

LEARNING MATERIAL ON

Computer Hardware and Maintenance

(For 5th Semester CSE)



Submitted By:
Manas Ranjan Mishra
Asst. prof. CSE

Need of management in a computer centre

To run an organisation efficiently and perfectly management is highly essential. To manage an organisation the following factors are responsible.

1. **Coordination between user, organisation and resources:** in management system there is a HR department that is responsible for managing staffs and resources of an organisation. The HR department decides various job assignments for various employees as per their experience and expertise and also this department is responsible for managing various resources of an organisation effectively.
2. **Maximum uses of resources:** In a computer organisation computer is the main resource of that organisation so the computer must be utilise efficiently, properly and perfectly so that a single computer can be handle by multiple users by adopting shift wise duty policy.
3. **Maintenance of resources:** To run an organisation perfectly, every resources must be maintained properly. Without maintenance the resources can be damaged. So all the resources can be maintained by appointing a consultant or a technical person.
4. **Distribution of raw material:** In every computer organisation the raw materials like hardware and software should be properly distributed to each user in 1:1 proportionate.
5. **Times slot for each user:** Time slot must be maintained by the HR department for the better utilisation of man power.
6. **Assignment of Task:** Staffs doesn't have all type of knowledge. So it is the duty of HR department to recognise each and every staff and assign duties as per their expertise.
7. **Discipline:** It is a very important factor for any organisation so discipline must be maintain among staffs without having discipline no organisation can perform better tasks.

Types of job carried out in a computer centre

The following types of jobs carried in a computer centre.

1. **Education training:** in this type of training various software developments, programming language and Hardware & networking training can be provided to various candidates by the expert professionals. This is also known as skill development programme. After completion of this training a candidate can handle a computer properly and perfectly and also he or she can develop various types of software using various types of computer languages.
2. **Accounting:** a computer can help preparing accounting statement, balance sheet and day to day financial activities by using special kind of accounting packages like tally or MSEXCEL.
3. **DTP work:** DTP stands for desktop publication. In this type of job user can type or draft a letter, prepare a presentation, prepare or edit a document using various word processing software like page maker, MS word, note pad, etc.

4. **Scientific purpose:** a computer can be used for any kind of scientific purpose like arrow space programme, nuclear programme, any kind of technical and defence research purpose etc.
5. **Industrial purpose:** a computer can be used in any kind of industry to perform various kinds of tasks like managing men power, managing raw material, managing and controlling production line, managing all financial activities etc.
6. **Data communication:** Now days a computer can be the main resource for data communication. Without having a computer data communication may not be easy task. Using computer information can be shared among users through internet.
7. **Business purpose:** A computer is very helpful in business purpose. By the help of a computer all types of business work can be carried out very easily. So computer is widely used in business purpose.

Duties and responsibilities of various persons

In a computer centre so many people are there to perform various tasks given by various departments. These persons are:

1. **Marketing group:** This group is responsible for creating awareness of computer among people. For creating this awareness they are preparing catalogue, circulating catalogue among people, motivating people and waiting for a response from the people. They are always in contact with the persons who are interested for computer training.
2. **Finance group:** This group is responsible for entire financial transaction of the organisation. This group is responsible for project costing and estimation. This group is also responsible for preparing balance sheet and day to day financial transaction of the organisation.
3. **Internal training group:** This group is responsible for planning and conducting various training programmes for professionals within the organisation and also outside the organisation so that the professional can keep them up to date as well as the organisation will also be up to dated.
4. **Software group:** The software group provides software solution to the professionals of the organisation. This group is also keep track records of software updates and latest software available in the market.
5. **Hardware consultancy group:** This group is responsible for entire hardware problem of the organisation. The staffs of this group maintaining and repairing all the hardware devices like computer, printer, server etc. This group is also responsible for updating and upgrading of hardware.
6. **Programme operation group:** This group is responsible for conducting training classes for the clients (those who are taking computer training). During this training class the programmers are writing programmes, explaining the logics behind the programme and handle any types of errors during programme.

Hierarchy of position of managers

There are mainly three levels of managerial group in an organisation. These groups are:

- 1. Upper level management:** The upper level managers are responsible for long term strategy, setting targets and objectives for the lower level manager. They are only answerable to the board of directors or governing body. They are responsible for their respective department.
- 2. Middle level management:** The middle level managers are responsible for short term planning. They are interface between upper level and lower level managers. They are getting long term decisions from upper level managers and plan accordingly to implement these decisions at lower levels. They are managing the organisation by taking the help of management information system.
- 3. Lower level management:** The lower level managers are performing the actual task of the organisation. They don't have the decision making capacity. They always doing their duties as directed by the middle level managers. They are always answerable to their immediate authority i.e. middle level manager.

Need of training for staffs

Due to rapid development of computer technology it is highly essential to train up employees for handling the latest hardware and software. Through training a staff can get new ideas as well as new technologies. Training is always help to keep an employee up-to-date of any organisation.

- 1. Need of training for upper level:** The need of training for upper level management are as follows:
 - To study about latest generation of computer concept in terms of hardware and software.
 - To have an idea in design, development and implementation of computer based system.
 - To get knowledge in operation research technique.
 - To get knowledge in latest programming languages and software.
- 2. Need of training of middle level:** The need of training for middle level management are as follows:
 - To get an idea about recent generation of computer, MIS(management information system)
 - To get an expose in the area of updated software and hardware technology
- 3. Need for training for lower level :** The need of training for the lower level management are:
 - To develop knowledge on hardware, software and latest technique in computer based information system
 - To expose himself/herself in the area of recent computer technology.

Various computers make and installations in India

For Hardware:

1. HCL (Hindustan Computer Limited), **2.** ZENITH Computer Limited, **3.** PCS (Patni Computers), **4.** Wipro InfoTech.

For Software (INDIAN MNCs):

1. Infosys, **2.** Tech Mahindra, **3.**TCS, **4.**Wipro Software

Site Selection

During the site preparation for a computer/server room, it is important to understand the infrastructure and the physical environment in which the lab will operate. The following information must be required before setting of a computer Lab.

- Weight and dimensions of the computer equipment.
- Electrical requirements of the computer equipment.
- Total heat generation and cooling requirements of the computer equipment.
- Types of signal and cables to be used.

The followings points must be considered during selection of a site for a computer Lab:

1. The computer room should be located away from the exterior walls of the building to avoid the heat gain from windows and exterior wall surfaces.
2. In case, exterior windows are unavoidable than all the windows should be shades with double- or triple-glazed UV protective material to prevent from direct sunlight entering into the computer room.
3. The floor should be sufficient weight tolerance capability for installing computer equipment.
4. Uniform room air distribution system should be installed in the computer room.
5. To avoid dust the site should be located away from heavy industries and areas with polluted air.
6. The computer room should not be on top floor, ground floor or in the basement of the building to avoid solar heat or water flood.
7. The computer room should be away from dangerous goods storage, heavy mechanical unit, excessive vibrations and high fire and water risk areas.
8. To eliminate the effect of electromagnetic interference, the computer room should be located away from generator room, the radar or telecommunication control rooms etc.
9. There should be minimum access by general public and irrelevant personnel to the computer room.

Layout of a Computer LAB

While setting up of a computer lab the following factors should be consider. These factors are:

1. **Fitting out Requirements:** All materials to be used in the computer room should be non-flammable, fire proof, and non-dust material. Any other materials that are not serving the computer room should be removed.
2. **Internal Partitions:** Partitions inside the computer room may be built to the headroom height for sufficient air circulation. Half-glazed partition is recommended for inside the computer room and double-glassed partitions may be considered for printer area due to noise reduction.
3. **Wall Finishing:** Internal walls must to be finished smoothly with liquid paint or wall papers. Light colour can enhance the illumination of the computer room.
4. **False Ceiling:** It is highly essential to cover the roof of the computer lab with false ceiling material like plaster of Paris because it reduces and maintains the room temperature of the computer room. It also used for fixing of various electrical fittings. The ceiling plate is preferred to be of easy remove and install type for the access of utilities in the ceiling. It also provides smartness and artistic effect to the computer room.
5. **Windows:** All the windows of a computer room should be shared with double or triple glazed UV materials to avoid direct sunlight.
6. **Main Entrance Door:** The main entrance door should be minimum 5 feet wide with double-leaf steel door having a 2-hour fireproof rating and secure bolted hinge is recommended. An auto door closer must be fitted in the door so that it will protect the AC and reduces the entry of dust inside.

7. **Emergency Exit:** The emergency exit requires an outward opening and self-closing steel door. It is also equipped with 2-hour fireproof rating and secure bolted hinge as the main entrance.
8. **Normal Lighting:** Evenly distributed lighting system is recommended for the computer room. It is necessary to align the lights in such a way so that shadows can be minimized.
9. **Emergency Lighting:** The lighting inside computer room should be connected to essential power supply and 50% of them should be supported by battery. The battery supported lights may be located at the ceiling area, main control panel area and passages leading to the main entrance and emergency exit.
10. **Air Conditioning:** Computer equipment are operated in an environment of controlled temperature and relative humidity. So the air conditioning system is highly essential to maintain the required room temperature and the humidity automatically. The operating range of temperature and relative humidity of computer equipment are usually $20^{\circ}\text{C} \pm 3^{\circ}\text{C}$.
11. **False Flooring:** False flooring is designed and developed to provide the following facilities inside the computer room. These are:
 1. A cold air distribution system can be installed for circulation of chilled air.
 2. Tracks or channels are installed for various data cabling.
 3. A copper cable can be lay down for grounding for various equipment.
 4. Various utility pipes can be lay down for water circulation.
12. **Dust Proofing:** This is another important factor to be considered while designing the computer Lab. Because dust particles create lots of problem in the computer. If a dust particle comes between read write head than the hard disk may not read and write data properly or it may damage the hard disk permanently. So to avoid dust particle the following precaution measures should be taken.
 1. Number of door and windows of the computer lab should be minimised.
 2. The lab should be Air Conditioned properly.
 3. The floor should be covered with anti-dust carpet.
 4. Shoes and other footwear should not be allowed inside the lab.

Power Supply

Computer and other equipment requires a clean and dedicated power source using various power conditioning devices like CVT, UPS, Isolation Circuit etc. Different type of computer equipment requires different type of power supply. The following power supply specification should be taken care during the installation of a computer lab.

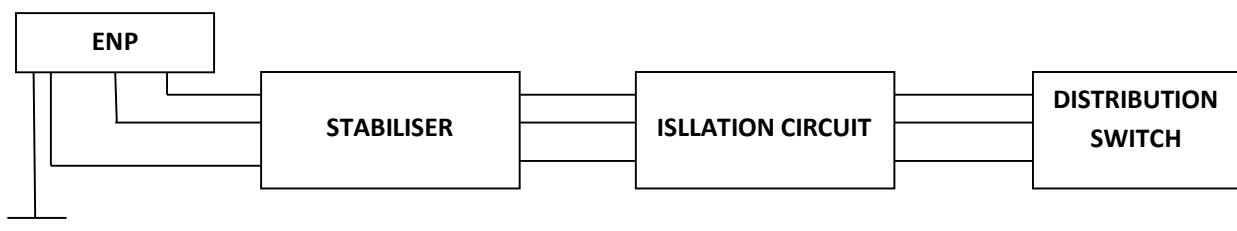

1. **Capacity or Load:** Sufficient power load or capacity should be provided to the computer lab so that each and every computer gets required power supply and it will also help future expansion of the computer lab.
2. **Voltage Standard:** The computer lab must be equipped with 3-phase power supply so that simultaneously we can run both the lab and the AC. The minimum voltage level for 3-Phase is 380 volt and for single phase it is 230 volt.
3. **Grounding:** A separate insulated copper grounding wire is highly essential for a computer lab to protect the computer and other equipment from the EMI and other damages due to high voltages.

Power Supply Problems

There are several types of power problems occurring inside the computer room. These problems are:

1. **Line Noise:** A small variation in the voltage level delivered to the computer is known as line noise. If the computer and other devices shearing the power supply with other EMI (Electro Magnetic Interference) Producing devices like Power generator, Washing Machine, Electric Water heater, Mechanical Machines than the line noise can be a serious problem for a computer. It may also damage the computer permanently
2. **Surge:** It is the sudden increase of voltage from standard voltage level to a higher voltage level and the high voltage can continue more than 3 Nano second is known as surge. The normal voltage level is 230 but due to surge it may increase to 1000 volt or even higher level. Due to Surge the computer may damage partially or permanently.
3. **Lightning:** Lightning can deliver a charge of millions of volts that can be a great chance of damage of any kind of electrical and electronic devices instead of using various power conditioning devices like CVT, UPS and surge protector. So to avoid the damage due lightning the computer room must be proper grounding facility.
4. **Brownout:** Sudden drop in the voltage level from a standard voltage level to a lower voltage level and immediately come back to its normal voltage level is known as Brownout. It may damage computer and other components of a computer.
5. **Blackout:** The total failure of power supply is known as blackout. If the power goes out during switch off mode of computer than there is no problem. But if the power goes out while performing any task in the computer than there is a chance of damage of the computer and components of computer.

Power Conditioning Devices

To provide safe guard and protect the computer from any kind of power problem we have to use various types' of power conditioning devices. These devices are:

CVT

Constant voltage transformer (CVT) is a device that is used for protecting sensitive computing and electronic devices from surges, sags and brownouts in the mains supply. CVT is also suitable for protecting sensitive loads against direct lightning strikes on power lines. It is also known as Ferro resonant transformer.

Working Principle

- Constant voltage transformer uses the unique principle of Ferro resonance, which is the periodic interchange of energy between a capacitor and an inductor.
- This type of transformer uses a tank circuit composed of a high-voltage resonant winding and a capacitor to produce a nearly constant average output voltage with a varying input current or varying load.
- The circuit has a primary winding on one side with a magnet force and the tuned circuit coil and secondary on the other side.
- The regulation is due to magnetic saturation in the section around the secondary.

Uses & Applications

Constant voltage transformer has many common uses & applications in various fields. Some of its common application includes:

- Protecting sensitive loads from direct lightning strikes on power lines.
- Riding out momentary breaks in the mains.
- Protect electrical and electronics equipment

Circuit Isolation or Isolation Circuit

It is a dedicated circuit and is protecting the most sensitive equipment from local noise and surge conditions. The Isolation Circuit can be protected a computer from voltage surges. In a number of situations, Isolation Circuit is enough to resolve the power problems.

- Isolation transformers use two sets of inductors coupled to a common magnetic core.
- These inductors are separated with magnetic shielding in specially shielded transformers.
- This shielding reduces or eliminates normal mode electrical noise by transferring it back to the ground system.
- The neutral and ground wires are bonded together on the output side of an isolation transformer to eliminate noise.

UPS

- UPS stands for Uninterrupted Power Supply. It is a device that allows our computer to keep running for at least a short time when the primary power source is lost. It also provides protection from power surges.
- A UPS contains a battery that starts when the device senses a loss of power from the primary source.
- When power surges occur, a UPS stops the surge so that it doesn't damage the computer.
- UPS usually provide protection against power surges, brownouts and line noise as well.

The UPS consists of three main components:

1. **Rectifier:** It receives AC power from main line than it converts the AC power supply into DC and provides the DC supply to the battery. The batter stores the DC voltages. Power failure only affects the battery charging process only because the battery is being charged by the rectifier.
2. **Battery:** It Stores the power for the use of the computer. When the power source is interrupted, immediately the battery provides the power supply to the computer.
3. **Inverter:** It converts the battery DC power into AC power for the use of computer and other equipment. The inverter provides continuous power supply to the computer just after the battery provides uninterrupted power to the inverter.

Offline UPS / Standby UPS:

In offline UPS, the AC power supply is the primary power source.

If a drop in current or voltage is detected by the UPS, it switches over to the backup battery automatically.

When AC power is restored, the UPS switches back. The switchover time should not be more than about 25 milliseconds which is the tolerance limit of a typical computer power unit.

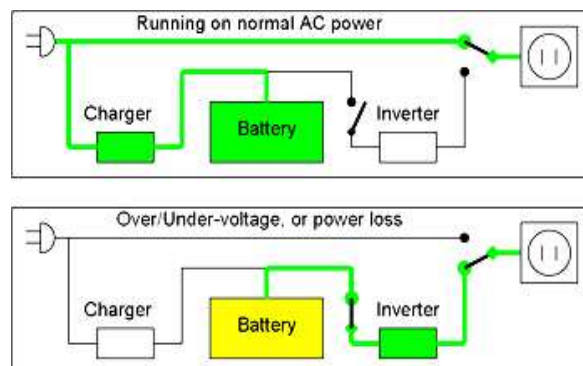

If the power failure is longer than the tolerance limit than the computer will shut down. This is the least expensive variety of uninterruptible power supplies and is used for the home user only.

Online UPS:

It converts AC power supply to DC and then converts the DC power supply back to AC and provides the power supply to the connected equipment. An additional benefit of this technology is that the system remains in the same operating mode.

In an online UPS, the batteries are always connected to the inverter, so that no power transfer switches are necessary.

When power loss occurs, the rectifier simply drops out of the circuit and the batteries provide the steady and unchanged power supply.

When power is restored, the rectifier resumes and starts charging the batteries, though the charging current may be limited to prevent the high-power rectifier from overheating the batteries and boiling off the electrolyte.

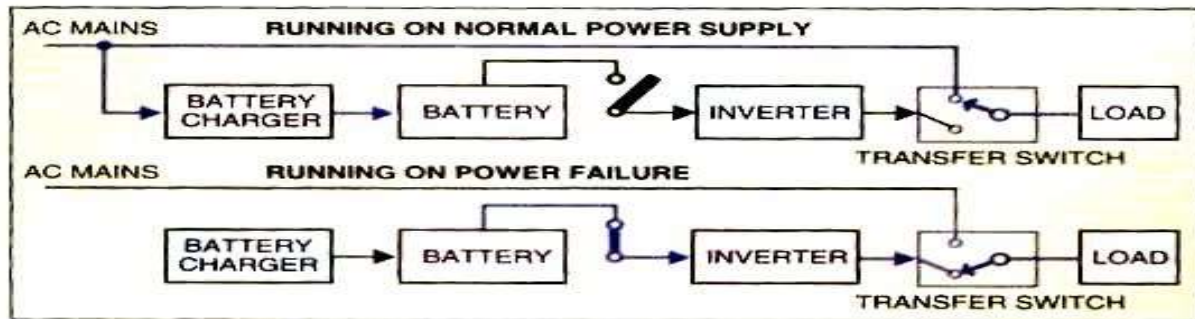

Block Diagram of an offline UPS

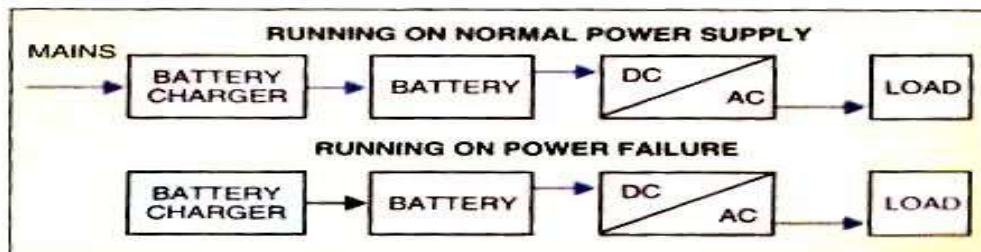

Block Diagram of an online UPS

Line Interactive UPS:

In this type of UPS, there is an inverter that plays a dual role of charging the battery when mains supply is present as well as regulating the output voltage and working as a normal inverter in absence of mains supply.

This type of UPS is able to tolerate continuous under voltage brownouts and overvoltage surges without consuming the limited reserve battery power. It instead compensates by automatically selecting different power taps on the autotransformer.

Surge Suppressor

- It is least expensive and most basic form of power protective device. It is also known as Spike Board.
- It consists of PVC or plastic block with multiple power outlets where computer and other devices can be connected.
- It receives AC power supply from the main supply and delivers the required voltage to connecting devices.
- It has power absorbing components to absorb high voltage like surge.
- It is used to prevent electronic devices from surge.

The Motherboard

Introduction

A motherboard is a printed circuit board or **main circuit board** in a personal computer and it contains all the sub systems and I/O ports like central processing unit (CPU), expansion slots, systems buses, memory modules, smaller circuit boards and peripheral devices.

Form Factors

The geometrical dimension and arrangement of all components of mother board is known as form factor of that mother board. In other words, the “shapes and sizes” of a motherboard is known as form factors. Motherboard comes in a variety of shapes and sizes. The various form factors are:

Components of Mother Board

The various important components of a Mother Board are as follows:

1. Processor socket/slot

The processor socket/slot locks the central processing unit (CPU) into its place and preventing the CPU from moving or being damaged. It also establishes the connection between the CPU and board so that data can be transferred to the CPU for processing.

Different models and types of computers require different types of CPU sockets, as not all CPUs are compatible with every kind of socket. The various socket types are:

- PGA Socket

A **pin grid array (PGA)** socket is usually a square package made up of a number of holes in an array. The CPU itself has the pins that insert into the socket. The arrangement of pins on the CPU must correspond to the slots on the socket; if not, the CPU will not connect properly to the board. To secure a CPU into a PGA socket, you have to press down until spring contacts lock it -- however, if you do not line up the pins properly, you may bend or damage them.

- ZIF Socket

A zero insertion force (ZIF) socket is an extension of a PGA socket, with pins on the CPU. With a ZIF socket, you don't have to press down on the CPU to lock it in place. Instead, you simply place the CPU into the socket, then lock it in using a lever or slider on the side of the socket. This results in less risk of you damaging the CPU when you try to insert or remove it from the socket.

- LGA Socket

A land grid array (LGA) socket is essentially the opposite of a PGA socket. Instead of having the pins connected to the CPU, they're connected to the socket itself while the CPU has slots with connectors. To lock a CPU into an LGA socket, you have to line up the pins and apply a small amount of pressure. LGA sockets are less fragile overall than PGA sockets, and you can also solder down the package using surface mount technology.

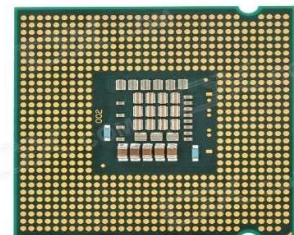
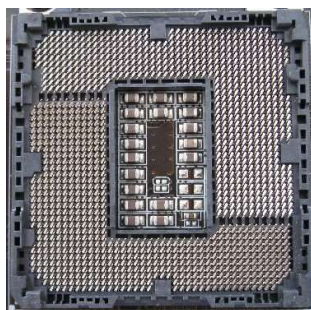

- **BGA Socket**

A ball grid array (BGA) is another variant on the PGA socket -- but instead of pins, a BGA socket has copper pads which that are soldered to the package. This means that you do not have to worry about damaging any of several hundred pins, especially as pin-chip architecture designs CPUs with pins closer and closer together. This also means there's less distance for data to travel, so there's less of a chance that the signals will distort.



2. **Memory Socket**

A **memory slot**, **memory socket**, or **RAM slot** is what allows RAM (Random Access Memory) to be inserted into the computer. Most motherboards have two to four **memory slots**, which determine the type of RAM used with the computer. The most common types of RAM are SDRAM and DDR for desktop computers and SODIMM for laptop computers, each having various types and speeds.

When buying a new computer or motherboard, pay close attention to the types of RAM the memory slots can accept. It is also important to note how many available memory slots are available in your computer. It is not necessary for a computer to have all memory slots occupied. If all slots are full and you want to upgrade the computer memory, you need to remove some or all of the existing memory.

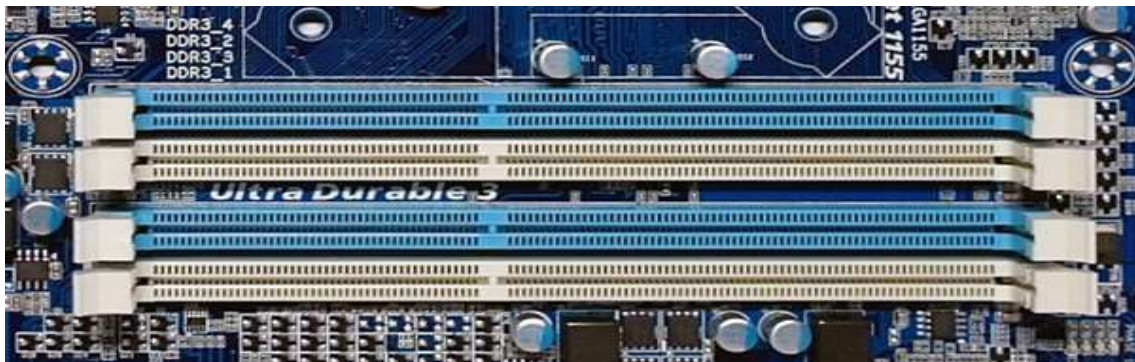

RAM SLOTS

3. **Cache Memory:**

The speed of CPU is extremely high compared to the main memory. Therefore the performance of CPU decreases due to the slow speed of main memory. To reduce this mismatch in operating speed, a small memory chip is attached between CPU and Main memory whose access time is very close to the processing speed of CPU. It is called CACHE memory. CACHE memories are accessed much faster than conventional RAM. It is used to store programs or data currently being executed or temporary data frequently used by the CPU.

Advantages

The advantages of cache memory are as follows –

- Cache memory is faster than main memory.
- It consumes less access time as compared to main memory.
- It stores the program that can be executed within a short period of time.
- It stores data for temporary use.

Disadvantages

The disadvantages of cache memory are as follows –

- Cache memory has limited capacity.
- It is very expensive.

4. Chip Set

A chipset is a group of interdependent motherboard chips or integrated circuits that control the flow of data and instructions between the central processing unit (CPU) or microprocessor and external devices. A chipset controls external buses, memory cache and some peripherals.

A chipset includes the circuit board layout/functionality and circuit mechanisms. Varieties include microprocessors and modem card chipsets. In addition, a CPU has several different chipsets that vary according to architecture.

A chipset has two sections – Southbridge and Northbridge – with specific sets of functions that communicate between the CPU and external devices.

The Southbridge, which is not directly connected to the CPU, is also known as the input/output controller hub. Southbridge handles the motherboard's slower connections, including input/output (I/O) devices and computer peripherals like expansion slots and hard disk drives.

The Northbridge connects the Southbridge to the CPU and is commonly known as the memory controller hub. The Northbridge handles a computer's faster interaction requirements and controls communication between the CPU, RAM, ROM, the basic input/output system (BIOS), the accelerated graphics port (AGP) and the Southbridge chip. The Northbridge links I/O signals directly to the CPU. The CPU uses the Northbridge frequency as a baseline for determining its operating frequency.

5. BIOS

BIOS stands for Basic Input Output System. It is a computer program that is stored in a ROM and used by the CPU to perform start-up procedures when the computer is turned on.

Before loading the operating system, the BIOS provides the basic **device drivers** (*Type of software used for running a hardware*) for all the hardware components of the PC's motherboard, including the keyboard, mouse, monitor and hard disk.

After start-up, the BIOS manages data flow between the OS and the peripherals.

Functions of BIOS

- **CMOS Setup:** CMOS known as complementary metal oxide semiconductor where the detail system information stored in a small amount of space located in the ROM and that can be altered as per the system requirement and the BIOS uses this information to modify or supplement its default programming as per the requirement.
- **POST** (power on self-test): The POST checks computer's processor, memory, chipset, video adapter, disk controllers, disk drives, keyboard, and other crucial components.
- **Setup:** The system configuration and setup program is usually a menu-driven program activated by pressing a special key during the POST, and it enables the user to configure the motherboard and chipset settings along with the date and time, passwords, disk drives, and other basic system settings. It can be used to control the power-management settings and boot-drive sequence from the BIOS Setup and it can also be used to configure CPU time and clock settings.

- **Bootstrap loader:** It is also known as **bootstrapping** or **boot loader**. A **bootstrap** loader is a program that resides in the computers ROM that automatically executed by the processor when the computer is turned on. The bootstrap loader reads the hard disk's boot sector to continue the process of loading the computers operating system.
- **BOOTP:** It is also known as **Bootstrap Protocol** is a TCP/IP protocol used by a diskless workstation to obtain its IP address and other network information such as server address and default gateway. During start-up, the client station sends a BOOTP request in a UDP packet to the BOOTP server. After receiving the request the server sends the required information i.e. an IP address to the workstation.
- **BIOS (basic input/output system):** This refers to the collection of actual drivers used to act as a basic interface between the operating system and the hardware when the system is booted and running. When running DOS or Windows in safe mode, we are running almost exclusively on ROM-based BIOS drivers because no drivers are loaded from the operating system.

6. Clock Generator

A clock generator is a type of circuit that produces a continuous, synchronized electrical signal for timing purposes in a wide variety of devices. Because many high-end electronic equipment require that electrical signals and mechanical devices work together in an efficient manner, clock generators are often a necessary component in many devices in order to ensure that all other components work harmoniously.



Working Principle of Clock Generators

Clock generators are generally made of a quartz or ceramic piezo-electric circuit board that includes an oscillator and an amplifier. As the piezo-electric material responds to changes in pressure, the oscillator produces a constant wave that repeats itself, such as a square wave, in order to synchronize external events. The amplifier receives and inverses this signal, passes it along to the output, and returns a portion of the signal back to the oscillator.

Applications of Clock Generator

Clock generators are used in computers to manage memory cards, peripheral devices, CPUs, ports, etc. In fact, computer experts often reset clock generators in order to control these devices' speed and performance. Clock generators are also used in telecommunication systems, digital switching systems, and many mechanical devices.

7. RTC

A real-time clock (RTC) is a battery-powered clock that is included in a microchip in a computer motherboard. This microchip is usually separate from the microprocessor and other chips and is often referred to simply as "the CMOS" (complementary metal-oxide semiconductor). A small memory on this microchip stores system description or setup values - including current time values stored by the real-time clock. The time values are for the year, month, date, hours, minutes, and seconds. When the computer is turned on, the Basic Input-Output Operating System (BIOS) that is stored in the computer's read-only memory (ROM) microchip reads the current time from the memory in the chip with the real-time clock.

8. I/O Controller

I/O controllers are a series of microchips which help in the communication of data between the central processing unit and the motherboard. The main purpose of this system is to help in the interaction of peripheral devices with the control units (CUs). Put simply, the I/O controller helps in the connection

and control of various peripheral devices, which are input and output devices. It is usually installed on the motherboard of a computer. I/O controllers are also known as channel I/O, DMA controllers, peripheral processors or I/O processors.

The I/O controllers are usually preinstalled on the motherboard of the computer. However, these devices can only accommodate certain common devices. Some unique devices may have a separate I/O controller. Such devices have to be connected to the computer using expansion slots

9. Power Connector

A **power supply unit** (or **PSU**) converts mains AC to low-voltage regulated DC power for the internal components of a computer. Modern personal computers universally use switched-mode power supplies. Some power supplies have a manual switch for selecting input voltage, while others automatically adapt to the mains voltage. Mainly there are two types of power connector can be used to provide power supply to the Mother Board and these are as follows:

AT Power Supply Connectors

Industry standard PC, XT, AT, Baby-AT, and LPX motherboards all use the same type of main power supply connectors. These supplies feature two main power connectors (P8 and P9), each with 6 pins that attach the power supply to the motherboard. All standard PC power supplies that use the P8 and P9 connectors have them installed end to end so that the two black wires (ground connections) on both power cables are next to each other. Some power supplies have them labelled as P1/P2 instead.

ATX Main Power Connector

ATX (Advanced Technology Extended) is a motherboard and power supply configuration specification developed by Intel in 1995 to improve on previous standards like the AT design. It was the first major change in desktop computer. Now ATX is the most common motherboard design.

An ATX power supply is typically controlled by an electronic switch connected to the power button on the computer case and allows the computer to be turned off by the operating system. In addition, many ATX power supplies have an equivalent-function manual switch on the back that also ensures no power is being sent to the components. When the switch on the power supply is turned off, however, the computer cannot be turned on with the front power button.

ATX TYPE CONNECTOR

10. Key Board Connector

Keyboard cables may utilize any one of a variety of connector types. As you type on the keyboard, the chip in the keyboard examines the matrix and decides what data to send into the PC. It preserves these figures in its memory buffer then sends the information. The various connector types are:

5 – Pin DIN Connector: The 5-pin DIN connector has been the very first predominant non- registered keyboard cable connector. This connector can be known as an AT connector.

6-PIN Mini DIN Connector: The 6-pin mini-DIN connector is a replacement for the 5-Pin layout. This **keyboard connector** is bigger and can be usually purple-colored to distinguish it from the same mouse connector. This sort of connector is generally known as a PS/2 connector and can also be called for its IBM system which has popularized it. This format is commonly utilized in desktop computers. It is used to perform the serial data transfer between peripherals of the PC to the laptop.

DIN is abbreviated for Deutsches Institute fur Normung or German Institute for Standardization, and it is a German production business standards group.

USB CONNECTOR: USB is one of the **keyboard cable connector types**. This tiny rectangular connector gives a significant upgrade within the DIN connector forms. USB connectors are hot-swappable, which means you can plug-in or plug-out without turning the machine on or off. AT and PS/2 devices aren't hot-swappable.

11. Mouse connector

A mouse connector is a dedicated socket or interface on the computer for connecting a mouse. Since the invention of the first personal computer by IBM back in 1981, different types of mouse connectors have been developed.

Bus Mouse: The first type of mouse was connected to the PC by the use of a **bus**, so it was actually being referred to as the bus mouse. It was used in the early days of the IBM-compatible personal computers.

Serial Mouse: The serial mouse was connected to the computer via the **serial port**. A serial port is a physical communication interface through which information is transferred in and out of the computer bit by bit.



The serial port is a D-type 9 pin male port (DB9M) at the back of the motherboard. Its corresponding connector must then be a female connector for them to mate correctly. The serial mouse is obsolete.

PS/2 Mouse: The **PS/2 mouse** is connected to the PS/2 port (green in colour). The PS/2 mouse connector is a 6-pin mini-din connector designed in 1987. It superseded the serial connectors. Its name is derived from the IBM's personal systems/2 series of personal computers, which were introduced in 1987.

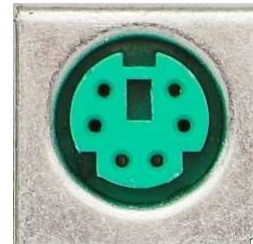

This PS/2 mouse port first featured in these PS/2 systems and continued being used in newer designs even after the PS/2 systems were no longer in production. The colour code for the PS/2 port for most computers is usually green.

12. Jumpers

Jumpers allow the computer to close an electrical circuit, allowing the electricity to flow on a circuit board and perform a function. Jumpers consist of small pins that can be covered with a small plastic box (**jumper block**).

Jumpers manually configure computer peripherals, such as the motherboard, hard drives, modems, sound cards, and other components. For example, if your motherboard supported intrusion detection, a jumper can be set to enable or disable this feature.



13. USB (Universal Serial Bus):

- Universal Serial Bus is a new connector which is introduced in 1995 to replace the Serial and Parallel ports. It is based on serial type architecture. However, it is much faster than standard serial ports.
- USB standard supports a wide range of devices like scanners, keyboards, mice, joysticks, printers, modems and External storage devices like PEN Drive, DVD or CD Drive.

- USB is completely hot-swappable that means we can connect or disconnect any device when the computer is running. Computer can recognize the device as soon as it plugged in, and the user can use of the device immediately. There are two types of USB connectors:

Type A: This type of connectors is generally used for less bandwidth intensive devices like keyboard, mouse, webcam, etc. and shape is rectangular.

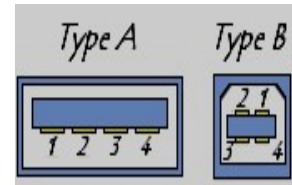

Type B: This type of connectors is generally used for high speed devices like external hard disks, etc. and shape is square.

14. VGA Port:

- VGA stands for Video Graphics Array. It is used to connect a monitor to a PC. It has three rows with 15 pins. It is also called RGB connector (red, green, blue).



15. NIC:

- NIC stands for Network Interface Card. It has RJ-45 female port with 8 nos of pin. It is also known as LAN or Ethernet port.
- It is commonly used for connecting the computer to a network.

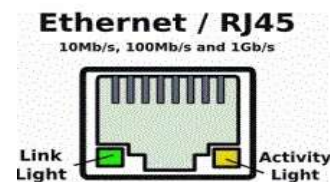

16. Audio Port:

There are three ports in audio plugs. They are:

- Line-in: It is used for both audio in and out
- Line-out: It is used for audio out only
- Microphone: It is used for inserting audio into PC

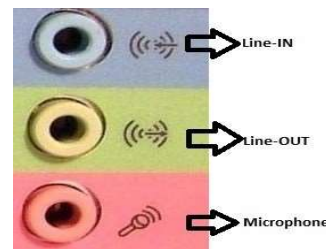

17. Cooling fan:

- It is used to lower the temperature of the CPU. It is mounted on an aluminium block called heat shrink. There are several other cooling fans are available in the computer case to maintain the temperature of a computer inside the case.

18. CMOS Battery:

- All personal computers require a small battery on the system board that provides power to the Complementary Metal Oxide Semiconductor (CMOS) chip, even while the computer is turned off.
- This chip contains information about the system configuration like hard disk type, floppy drive types, date and time, and the order in which the computer will look for bootable dis. The CMOS battery allows the CMOS to preserve these settings.



19. Floppy Drive Interface:

By using this interface a floppy drive can be connected through a 34-pin ribbon cable. It controls the data flow between a floppy and the computer. It has 34pins.

20. IDE Port:

IDE stands for integrated device electronics. This port is available in the motherboard for the communication between IDE devices and the Motherboard through a 40 pin ribbon cable. IDE controller is responsible for controlling the IDE devices.

21. Serial Port:

- Serial ports are also known as COM port or **RS-232**. The term serial means data can be send bit by bit using a single cable.
- Serial ports are generally built into the mother board, and can be used to connect exterior devices like external modem, serial mouse, etc. Serial connector has generally 9 or 25 pins and looks like “D” shaped. It is also called DB9 and DB25 connectors respectively.

22. Parallel Port:

- Parallel port looks like same as DB25 female connector but it is transmitting data of eight bits at a time as compared to serial port.
- The parallel ports on personal computers can be used to send 8 bits (one octet) simultaneously via 8 wires.
- Parallel port supports printer and other devices like Zip drives and scanners etc.

23. Expansion Slots of Motherboard

Expansion slots:

Expansion slots are usually interfaces to communicate between physical devices with motherboard. All the motherboard has one or more system expansion Slots that are used to expand the computer capabilities. The slots are like ISA, EISA, PCI, VESA etc. are placed near to the back panel of the Mother board.

- **ISA:** Stands for "Industry Standard Architecture." The ISA bus was developed in 1981. ISA is a type of bus used in PCs for adding expansion cards like video card, network card, or an extra serial port. The 8-bit version of ISA uses 62 pin connection and supports clock speeds of 8 and 33 MHz and the 16-bit ISA uses 98 pins and supports the same clock speeds. Later it was replaced by PCI bus, which offered a better performance.
- **EISA Bus:** The **EISA bus** stands for Extended Industry Standard Architecture. It was developed in 1988 by a group of companies (AST, Compaq, Epson, Hewlett-Packard, NEC, Olivetti, Tandy, Wyse and Zenith) in order to compete with the MCA (Micro Channel Architecture) bus that was developed by IBM.
- **VESA Local Bus or VL- Bus:** In 1992, the **VESA local bus (VLB)** was developed by the VESA (Video Electronics Standard Association) in order to provide a local bus dedicated to graphics systems. The VLB or VL-bus is a hardware interface on the computer's motherboard that is attached to an expansion slot. Extra graphics capabilities can be added by connecting a video expansion card to the VLB slot. The interface supports 32-bit data flow at up to 50 MHz
- **PCI Bus:** Stands for "Peripheral Component Interconnect." It is a hardware bus designed by Intel around 1992 and is used in both PCs and Macs. It is an intermediate bus located between the processor bus (Northbridge) and the I/O bus (Southbridge). Most add-on cards such as SCSI, Fire wire, and USB controllers use a PCI connection. Some graphics cards also uses PCI slot, but most new graphics cards connect to the AGP slot. The PCI interface exists in 32 bits with a 124-pin connector or in 64 bits with a 188-pin connector. There are also two signalling voltage levels i.e. 3.3V for laptop computers and 5V for desktop computers.



32-bit PCI connector 3.3V



32-bit PCI connector 5V

AGP: Stands for "Accelerated Graphics Port." AGP is a type of expansion slot designed for graphics purpose only. It was developed in 1996 as an alternative to the PCI standard. AGP interface provides a dedicated bus for graphics data.

AGP slots are built into a computer's motherboard and have a similar form factor to PCI slots. AGP can be used only in desktop pc as it requires an expansion slot.

Processor

CPU alternately referred to as a **processor**, **central processor**, or **microprocessor**, the **CPU** (pronounced sea-pea-you) is the **central processing unit** of the computer. A computer's CPU handles all instructions it receives from hardware and software running on the computer.

The CPU was first developed at Intel with the help of Ted Hoff and others in the early 1970s. The first processor released by Intel was the 4004 processor

Function of CPU

The CPU's main function is to take input from a peripheral (keyboard, mouse, printer, etc.) or computer program, and interpret what it needs. The CPU then either outputs information to your monitor or performs the peripheral's requested task.

Components of the CPU

In the CPU, there are two primary components.

1. ALU (arithmetic logic unit) - performs mathematical, logical, and decision operations.
2. CU (control unit) - directs all the processors operations.

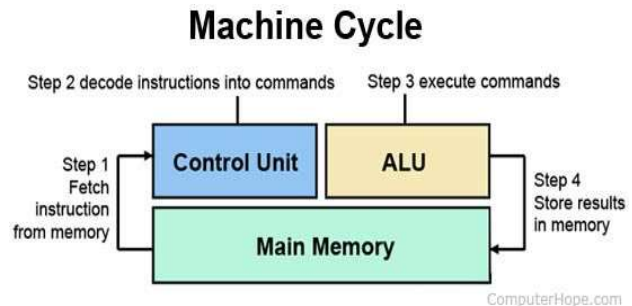

1. Core2 Duo Processor

The Intel Core 2 Duo processor is a **64 bit** dual core processor. This means **two processor cores** work inside a Core 2 Duo in **parallel**.

The Core 2 Duo, which was introduced on July 27 2006, is the direct successor of the Core Duo. Each core is based on the Pentium M micro architecture. Compared with the old Net burst architecture of the Pentium 4.

Key Features

- 64 bit support
- Dual core processor with shared level 2 cache
- Execute Disable Bit
- Partially Intel Virtualization Technology (VT)
- Socket M (starting from Santa Rosa socket P)
- 291 million transistors

The Intel Core 2 Duo uses the x86 instruction set, which was introduced in 1978 with the 8086/8088 processor. Furthermore, it supports the multimedia extension MMX, SSE2, SSE3 and SSE4.

2. Quad Core Processor

A quad-core processor is a multiprocessor architecture that is designed to provide faster processing power. It is a successor to the dual-core processor, which has two processor cores. Quad-core processors integrate two dual-core processors within a single processor. The two separate dual cores communicate with each other using processor cache. A quad-core processor can execute multiple instructions simultaneously, meaning that each core can be dedicated for separate instruction.

Although quad-core processors increase the processing performance of a computer by a significant margin, system speed also depends on other computing components to deliver overall computing performance.

3. Intel I series Processor

- **i3 Processor:** The **Core i3** is a dual-core computer processor, available for use in both desktop and laptop computers. It is one of three types of processors in the "i" series (also called the Intel Core family of processors). The Core i3 processor is available in multiple speeds, ranging from 1.30 GHz up to 3.50 GHz, and features either 3 MB or 4 MB of cache.

It utilizes either the LGA 1150 or LGA 1155 socket on a motherboard. Core i3 processors are most often found as dual-core, having two cores. However, a select few high-end Core i3 processors are quad-core, featuring four cores. The most common type of RAM used with Core i3 processor is DDR3 1333 or DDR3 1600.

Power usage varies for the Core i3 processors:

- Slower speeds (1.30 GHz to 1.80 GHz) use 11.5 W, 15 W or 25 W of power
 - Medium speeds (2.00 GHz to 2.50 GHz) use 28 W, 35 W or 37 W of power
 - Faster speeds (2.90 GHz to 3.50 GHz) use 35 W, 37 W or 54 W of power
- **i5 Processor:** The **Core i5** is a computer processor, available as dual-core or quad-core. It can be used in both desktop and laptop computers, and is one of four types of processors in the "i" (Intel Core family) series. The first i5 processor was released in September 2009 and new generations of the i5 continue to be released (2020).

The Core i5 processor is available in multiple speeds, ranging from 1.90 GHz up to 3.80 GHz, and it features 3 MB, 4 MB or 6 MB of cache. It utilizes either the LGA 1150 or LGA 1155 socket on a motherboard. Core i5 processors are most often found as quad-core, having four cores. However, a select few high-end Core i5 processors feature six cores.

The most common type of RAM used with a Core i5 processor is DDR3 1333 or DDR3 1600. However, higher performance RAM can be used as well if it's supported by the motherboard.

Power usage varies for the Core i5 processors:

- Slower speeds (1.90 GHz to 2.30 GHz) use 11.5 W of power
 - Medium speeds (2.60 GHz to 3.10 GHz) use 15 W, 25 W, 28 W or 37 W of power
 - Faster speeds (3.20 GHz to 3.80 GHz) use 35 W, 37 W, 45 W, 47 W, 65 W or 84 W of power
- **i7 Processor:** **Intel Core i7** is a line of Intel CPUs which span eight generations of Intel chipsets. They feature either four or six cores, with frequencies between 2.6 and 3.7 GHz. The first i7 processors were released in November 2008 and new generations of the i7 continue to be released (2020).

The i7 processor is marketed primarily to gaming enthusiasts, and digital artists such as filmmakers and animators.

In June 2018, Intel announced a limited edition i7 processor, the i7-8086K. It is the first Intel processor to reach speeds of 5 GHz without using Intel Turbo Boost technology.

4. AMD A10 series

AMD is known as **Advanced Micro Devices**, is a computer company best known for its computer processors. The **AMD A10** is a mobile quad-core processor based on the Trinity architecture. The processing unit is manufactured in 32nm SOI and integrates a 2.3 GHz CPU (up to 3.2 GHz w/ Turbo Core) with a relatively fast Radeon HD 7660G GPU alongside a dual-channel memory controller, video encoders and a Northbridge.

























5. XEON Processor

The **Xeon** is a high-end Intel processor for enterprise servers and **workstations** that runs on compatible Xeon motherboards. Xeon processors use a Slot 2 form factor and are available in the speed starting at 400 [MHz](#). It was released in June 2004 and all Intel Xeon processors are 64-bit processors.

It has some advanced features such as support for ECC memory, higher core counts, support for larger amounts of RAM, larger cache memory and extra provision for enterprise-grade reliability, availability and serviceability (RAS) features responsible for handling hardware exceptions through the Machine Check Architecture. (In computing, **Machine Check Architecture (MCA)** is an Intel mechanism in which the CPU reports hardware errors to the operating system.)

Color-coding scheme for connectors and ports

Perhaps the most end-user visible and lasting impact of PC 99 was that. As many of the connectors look very similar, it was very necessary it to introduce a color code for the various standard types of plugs and connectors used on PCs particularly for a beginner PC user, this made it far easier for people to connect peripherals to the correct ports on a PC. This color code was gradually adopted by almost all PC and motherboard manufacturers. Some of the color codes have also been widely adopted by peripheral manufacturers.

Color	Function	Connector on PC
User input		
	Green PS/2 mouse / pointing device	6-pin mini-DIN female
	Purple PS/2 keyboard	6-pin mini-DIN female
	Gold Game port / MIDI	15-pin D female
General input/output		
	White USB 1 low speed and full speed	USB Type A receptacle
	Black USB 2.0 high speed	USB Type A receptacle
	Sky blue USB 3.0 SuperSpeed	USB Type A SuperSpeed receptacle
	Yellow USB 3.0 SuperSpeed Always On even if the PC is turned off	USB Type A SuperSpeed receptacle
	Red High-power USB (more than 500 mA current available)	USB Type A receptacle
	Grey IEEE 1394 (FireWire)	6-pin FireWire 400 or 9-pin FireWire
	Burgundy Parallel port	25-pin D female
	Teal or turquoise Serial port	9-pin D male
Video		
	Blue Analog monitor	15-pin VGA female
	White Digital monitor	DVI female
	Yellow S-Video	4-pin mini-DIN
	Yellow Composite video	RCA jack
	Black Digital audio/video	HDMI or DisplayPort female
Audio		
	Pink Analog microphone audio input (mono or stereo)	3.5 mm TRS
	Light blue Analog line level audio input	3.5 mm TRS
	Lime green Analog line level audio output, front stereo (speakers or	3.5 mm TRS
	Black Analog line level audio output, rear stereo (surround speakers)	3.5 mm TRS
	Orange Analog line level audio output, center and subwoofer (surround	3.5 mm TRS
	Silver Analog line level audio output, side stereo (surround speakers)	3.5 mm TRS
	Orange Digital audio output (coaxial S/PDIF)	RCA connector
	Black Digital audio output (optical S/PDIF)	TOSLINK

MEMORY AND I/O DEVICES

MEMORY

Memory is the most essential element of a computing system because without it computer can't perform simple tasks. Memories are made up of registers. Each register in the memory is one storage location. Storage location is also called as memory location. Memory locations are identified using **Address**. The total number of bit a memory can store is its **capacity**.

A storage element is called a **Cell**. Each register is made up of storage element in which one bit of data is stored. The data in a memory are stored and retrieved by the process called **writing** and **reading** respectively.

The memory of a computer is classified in the two categories **primary** and **secondary** memory. **Primary memory** is the **main memory** of the computer where the currently processing data resides. The **secondary memory** of the computer is **auxiliary memory** where the data that has to be stored for a **long time** or **permanently**, is kept.

Computer memory is of two basic type – Primary memory (RAM and ROM) and Secondary memory (hard drive, CD, Floppy Drive etc.). Random Access Memory (RAM) is primary-volatile memory and Read Only Memory (ROM) is primary-non-volatile memory.

Primary Memory

Primary memory, also known as the main memory, is the area in a computer which stores data and information for fast access. It's a memory which is used to store frequently used programs which can be directly accessed by the processing unit for further processing. It's a volatile memory meaning the data is stored temporarily and is liable to change or lose in case of power failure. In simple terms, data is intact as long as the computer is running and the moment it's off, data is lost.

Primary Memory Types

RAM: Stands for Random Access Memory. It is volatile in nature. When the computer is switched off, all the data from the storage location are deleted. It stores data as long as the power supply is there. RAM is composed of a series of chips which allow for temporary data storage only. There are basically two types of RAM

1. DRAM (Dynamic RAM)
2. SRAM (static RAM)

DRAM (Dynamic RAM)

DRAM stands for Dynamic RAM, and it is the most common type of RAM used in computers. The oldest type is known as single data rate (SDR) DRAM, but newer computers use faster dual data rate (DDR) DRAM. DDR comes in several versions including DDR2 , DDR3, and DDR4, which offer better performance and are more energy efficient than DDR.

Each DRAM memory cell is made up of a transistor and a capacitor within an integrated circuit, and a data bit is stored in the capacitor.

The types of DRAM packages

- **Single In-Line Memory Module (SIMM)**

SIMM modules were widely used from the late 1980s to 1990s, and are now obsolete. They typically had 32-bit data bus and were available in two physical types—30- and 72-pin.

- **Dual In-Line Memory Module (DIMM)**

Current memory modules come in DIMMs. "Dual in-line" refers to pins on both sides of the modules. A DIMM originally had a 168-pin connector supporting 64-bit data bus, which is twice the data width of SIMMs. The wider bus means that more data can pass through a DIMM, translating to faster overall performance. Latest DIMMs based on fourth-generation double data rate (DDR4) SDRAM have 288-pin connectors for increased data throughput.

Common types of DRAM

1. **Synchronous DRAM (SDRAM)** "synchronizes" the memory speed with CPU clock speed so that the memory controller knows the exact clock cycle when the requested data will be ready. This allows the CPU to perform more instructions at a given time. Typical SDRAM transfers data at speeds up to 133 MHz.
2. **Rambus DRAM (RDRAM)** takes its name after the company that made it, Rambus. It was popular in the early 2000s and was mainly used for video game devices and graphics cards, with transfer speeds up to 1 GHz.
3. **Double Data Rate SDRAM (DDR SDRAM)** is a type of synchronous memory that nearly doubles the bandwidth of a single data rate (SDR) SDRAM running at the same clock frequency by employing a method called "double pumping," which allows transfer of data on both the rising and falling edges of the clock signal without any increase in clock frequency.
4. **DDR1 SDRAM** has been succeeded by **DDR2**, **DDR3**, and most recently, **DDR4** SDRAM. Although operating on the same principles, the modules are not backward-compatible. Each generation delivers higher transfer rates and faster performance. The latest DDR4 modules, for example, feature fast transfer rates at 2133/2400/2666 and even 3200 MT/s.

SRAM (static RAM)

SRAM stands for Static RAM, and it is a particular type of RAM which is faster than DRAM, but more expensive and bulkier, having six transistors in each cell. For those reasons SRAM is generally only used as a data cache within a CPU itself or as RAM in very high-end server systems. A small SRAM cache of the most imminently-needed data can result in significant speed improvements in a system

ROM: ROM stands for read-only memory. It is non-volatile, which means it can retain data even without power. It is used mainly to start or boot up a computer. Once the operating system is loaded, the computer uses **RAM**, which stands for random-access memory, which temporarily stores data while the central processing unit (CPU) is executing other tasks. With more RAM on the computer, the less the CPU has to read data from the external or secondary memory (storage device), allowing the computer to run faster. RAM is fast but it is volatile, which means it will not retain data if there is no power. It is therefore important to save data to the storage device before the system is turned off.

Types of ROM

ROM is available in several different types, including PROM, EPROM, and EEPROM.

1. **PROM (Programmable read-only memory)** – It can be programmed by user. Once programmed, the data and instructions in it cannot be changed.

2. **EPROM (Erasable Programmable read only memory)** – It can be reprogrammed. To erase data from it, expose it to ultra violet light. To reprogram it, erase all the previous data.
3. **EEPROM (Electrically erasable programmable read only memory)** – The data can be erased by applying electric field, no need of ultra violet light. We can erase only portions of the chip.

Secondary Memory

Secondary memory is an **auxiliary memory** of the computer. The data that has to be **permanently** stored is kept in secondary memory. The CPU **cannot directly access** the data in secondary memory. The data has to be initially copied to primary memory then only it can be processed by CPU. Hence, accessing data from secondary memory is **slower**. The secondary memory can be accessed using the **input-output channel**.

The secondary memory is **non-volatile** in nature, which means that the content of the secondary memory exist even if the power is switched off. Secondary memory refers to all external storage devices that are capable of storing high volumes of data such as hard drives, floppy disks, magnetic tapes, USB flash drives, CDs, DVDs, etc. It's generally slower than primary memory but can store substantial amount of data, in the range of gigabytes to terabytes.

Uses of Secondary Media:

- **Permanent Storage:** Primary Memory (RAM) is volatile, i.e. it loses all information when the electricity is turned off, so in order to secure the data permanently in the device, Secondary storage devices are needed.
- **Portability:** Storage medium, like the CDs, flash drives can be used to transfer the data from one device to another.

Secondary Memory Types

1. Magnetic storage media:

Magnetic media is coated with a magnetic layer which is magnetized in clockwise or anticlockwise directions. When the disk moves, the head interprets the data stored at a specific location in binary 1s and 0s at reading. **Examples:** hard disks, floppy disks and magnetic tapes.

- **Floppy Disk:** A floppy disk is a flexible disk with a magnetic coating on it. It is packaged inside a protective plastic envelope. These are one of the oldest type of portable storage devices that could store up to 1.44 MB of data but now they are not used due to very less memory storage.
- **Hard disk:** A hard disk consists of one or more circular disks called platters which are mounted on a common spindle. Each surface of a platter is coated with a magnetic material. Both surfaces of each disk are capable of storing data except the top and bottom disk where only the inner surface is used. The information is recorded on the surface of the rotating disk by magnetic read/write heads. These heads are joined to a common arm known as access arm.

2. Optical storage media:

In optical storage media information is stored and read using a laser beam. The data is stored as a spiral pattern of pits and ridges denoting binary 0 and binary 1.

Examples: CDs and DVDs

- **Compact Disk:** A Compact Disc drive (CDD) is a device that a computer uses to read data that is encoded digitally on a compact disc (CD). A CD drive can be installed inside a computer's compartment, provided with an opening for easier disc tray access or it can be used by a peripheral device connected to one of the ports provided in the computer system. A compact disc or CD can store approximately 650 to 700 megabytes of data. A computer should possess a CD Drive to read the CDs.

- **DVD:** It stands for Digital Versatile Disk or Digital Video Disk. It looks just like a CD and use a similar technology as that of the CDs but allows tracks to be spaced closely enough to store data that is more than six times the CD's capacity. It is a significant advancement in portable storage technology. A DVD holds 4.7 GB to 17 GB of data.
- **Blue Ray Disk:** This is the latest optical storage media to store high definition audio and video. It is similar to a CD or DVD but can store up to 27 GB of data on a single layer disk and up to 54 GB of data on a dual layer disk. While CDs or DVDs use red laser beam, the blue ray disk uses a blue laser to read/write data on a disk.

3. Solid State Memories:

Solid-state storage devices are based on electronic circuits with no moving parts like the reels of tape, spinning discs etc. Solid-state storage devices use special memories called flash memory to store data. Solid state drive (or flash memory) is used mainly in digital cameras, pen drives or USB flash drives.

- **Pen Drives:**
Pen Drives or Thumb drives or Flash drives are the recently emerged portable storage media. It is an EEPROM based flash memory which can be repeatedly erased and written using electric signals. This memory is accompanied with a USB connector which enables the pen drive to connect to the computer. They have a capacity smaller than a hard disk but greater than a CD.
- **Flash:**
Flash memory is non-volatile computer memory for persistent storage and data transfers between PCs and digital devices. Flash's high-speed programmable memory performs fast random I/O operations.

Difference between Primary memory and Secondary memory:

SL NO	PRIMARY MEMORY	SECONDARY MEMORY
1	Primary memory is temporary.	Secondary memory is permanent.
2	Primary memory is directly accessible by Processor/CPU.	Secondary memory is not directly accessible by the .CPU
3	Nature of Parts of Primary memory varies, RAM- volatile in nature. ROM- Non-volatile.	It's always Non-volatile in nature.
4	Primary memory devices are more expensive than secondary storage devices.	Secondary memory devices are less expensive when compared to primary memory devices
5	The memory devices used for primary memory are semiconductor memories.	The secondary memory devices are magnetic and optical memories.
6	Primary memory is also known as Main memory or Internal memory.	Secondary memory is also known as External memory or Auxiliary memory
7	Examples: RAM, ROM, Cache memory, PROM, EPROM, Registers, etc.	Examples: Hard Disk, Floppy Disk, Magnetic Tapes, etc.

Memory Speed

Memory Speed is the amount of time that it takes RAM to receive a request from the processor and then read or write data. Generally, the faster the RAM, the faster the processing speed. With faster RAM, you increase the speed at which memory transfers information to other components. RAM speed is measured in Megahertz (MHz), millions of cycles per second so that it can be compared to the processor's clock speed.

Access time

Access time in a computer memory is the time required to both locate and retrieve the data. Memory access time is how long it takes for a character in memory to be transferred to or from the CPU. In a PC or Mac, fast RAM chips have an access time of 70 nanoseconds (ns) or less. SDRAM chips have a burst mode that obtains the second and subsequent characters in 10 ns or less.

DRAM (dynamic random-access memory) chips for personal computers have access times of 50 to 150 nanoseconds (billionths of a second). Static RAM (SRAM) has access times as low as 10 nanoseconds. Ideally, the access time of memory should be fast enough to keep up with the CPU.

Hard disk

Hard disk was invented in the 1950s. It was originally called "fixed disks" or "Winchesters" (a code name used for a popular IBM product). Hard Disk is the main storage media device used to store data permanently in the computer. A hard disk consists of one or more circular disks called platters which are mounted on a common spindle. Each surface of a platter is coated with a magnetic material. Both surfaces of each disk are capable of storing data except the top and bottom disk where only the inner surface is used. The information is recorded on the surface of the rotating disk by magnetic read/write heads. These heads are joined to a common arm known as access arm.

Types of HDD

1. SCSI Type

Stands for **Small Computer System Interface, SCSI**, pronounced as "**Scuzzy**", is the second most commonly used interface for disk drives and was introduced in [1982](#). SCSI is a standard for parallel interfaces that transfers information at a rate of eight bits per second and faster, which is faster than the average parallel interface.

2. ATA/IDE Type

IDE (**I**ntegrated **D**rive **E**lectronics) is more commonly known as [ATA](#) (**A**T **A**ttachment) and is a standard interface for IBM compatible hard drives. IDE and its updated successor is known as Enhanced IDE (EIDE) and are the most common drive interfaces found in IBM compatible computers today. IDE cables can be distinguished by their wide 40-pin connector.

PATA: Stands for Parallel ATA. Originally **AT Attachment** is an interface standard for the connection of storage devices such as hard disks, floppy drives, and optical disc drives in computers.

SATA: Stands for serial ATA. SATA drives reach up to 10,000 RPM. If you want Serial ATA, you will either need to purchase a motherboard that supports it, or purchase a PCI card that will allow you to connect your hard drive.

Basic Hard Disk Drive Components

DISK Platters

One or more aluminum, glass, or ceramic disk that is coated in a magnetic media and is located within a hard disk drive to permanently store all your computer's data. When the computer is turned on, these platters will begin to rotate at so many rotations per minute (RPM). This rate varies depending upon the model of hard drive you have; an example of how fast a hard drive may spin is 7200 RPM. As the disk platters are rotating, the read/write head accesses information on one of the platters. To help store and retrieve the data from the **platter**, data is stored in tracks, sectors and cylinders on each platter.

Head Actuators

The head actuator, which contains a voice-coil motor, called rotary coil motor or servos, to actuate the head movement, and an electromagnetic coil that can move a magnet very rapidly move the arms. As current flows through the coil, a magnetic field is generated that opposes the permanent magnet. This force of opposition causes a deflection that is directly proportional to the amount of driving current greater current signals result in greater opposition and greater deflection. The head movement is generally based on the position of head i.e. centered on the exact track, otherwise, aerodynamics disturbance, that is, thermal effects in the platters, variation in voice coil driver signals checked and adjusted in real time to ensure that desired tracks are followed exactly.

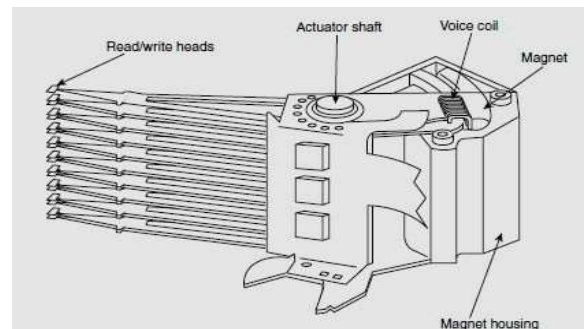

Read/Write Heads

Read-write heads for each side of each platter are mounted on arms that move them towards the central spindle or towards the edge. These heads are connected, or ganged, on a single movement mechanism. The heads, therefore, move across the platters in unison. When the drive is at rest, the heads are forced into direct contact with the platters by spring tension, but when the drive is spinning at full speed, air pressure develops below the heads and lifts them off the surface of the platter. On a drive spinning at full speed, the distance between the heads and the platter can be anywhere from 0.5 μ -inches to 5 μ -inches or more in a modern drive.

Spindle motor

The spindle motor, also sometimes called the spindle shaft, is responsible for turning the hard disk platters, allowing the hard drive to operate. The spindle motor is sort of a "work horse" of the hard disk. It's not flashy, but it must provide stable, reliable and consistent turning power for thousands of hours of often continuous use, to allow the hard disk to function properly.

Logic Board

All hard disk drives have one or more logic boards mounted on them. The logic boards contain the electronics that control the drive's spindle and head actuator systems and present data to the controller in some agreed-upon form. On ATA drives, the boards include the controller itself, whereas SCSI drives include the controller and the SCSI bus adapter circuit. The logic board has its own processor and memory and perform its function independently.

Working Principle of HDD

- Magnetic platters that hold binary information
- A central spindle that lets the platters spin at rapid rates
- Electromagnets known as read-write heads
- Read-write arms that move the read-write heads across the platter surfaces
- Small spindles that permit the motion of the read-write arms
- Actuators, such as stepper motors or voice coils, that move the read-write arms accurately
- Bottom-mounted control circuit boards that regulate data transmission
- External plug connectors that let users hook their drives up to computers

File System

A file system is a process that manages how and where data on a storage disk, typically a hard disk drive (HDD), is stored, accessed and managed. It is a logical disk component that manages a disk's internal operations as it relates to a computer and is abstract to a human user. Commonly used file systems include File Allocation Table 32 (FAT 32), New Technology File System (NTFS).

FAT16: This file system is referred for DOS. The file management in FAT16 operating system is not so flexible. The FAT16 cluster management is less comparable to other file systems.

FAT32: It is referred by all the DOS-based OS (Win95 to Win2003Server). This file system provides better file management and clustering than FAT16 file system. The easier interaction with flexible memory swapping option is available with FAT32 file system. FAT32 never provides the server administration part because of poor cluster management.

NTFS: It's known as 'New Technology File System'. It is specifically generated for the network administration management that's known as 'Server'. The advantage of this file system is known as 'Auto-clustering' i.e. the disk defragmentation takes place automatically. The advantage is the database is highly secured.

PARTITIONING AND FORMATTING OF HARD DISK

Partitioning the drive is the process of dividing the physical drive space into pieces called 'partitions or logic volumes. Partitions are electronic, logical divisions of a hard drive that provide tremendous flexibility in hard

drive organization. Partitions are one of the major disk structures that define how the disk is laid out. In fact, one must partition a drive even if he is only putting all of the space into a single volume. Partitioning is important because partition size and type will have an important impact on both performance and disk space efficiency.

There are several file systems in service today, but operating systems like DOS and Windows 9x/ME continue to use the file allocation table (FAT) system. The main criticism of FAT is that sectors are grouped and assigned as 'clusters' and this can be wasteful of drive space. One of the newly created partitions will be assigned as the boot partition, and a *master boot record* (MBR) containing special boot code and a partition table will be written to the first sector. FDISK is the DOS/Windows utility used for drive partitioning.

The master boot record (MBR) is information that is normally stored in the first sector of the hard drive. This information is simply a small data structure that identifies where an operating system is located on the drive so that the OS can be loaded into the system's memory (RAM) at boot time. The MBR contains two elements; executable code and a 'partition table', which identifies each partition residing on the hard drive. The MBR executable code begins the boot process by looking up the partition table to determine what partition holds the operating system. It then loads the boot sector of the partition containing the OS into RAM, and transfers the execution of the 'program' to the partition boot sector. The partition boot sector then finishes loading the operating system files into RAM.

FORMATTING

Even after partitioning, an operating system cannot store files on a drive. A series of data structures must be written to the drive. A volume boot sector (VBS), two copies of the 'file allocation table (FAT) ', and a root directory are written to each logical partition. High-level formatting also checks and locks out bad sectors so that they will not be used during normal operation. FORMAT is the DOS utility used for high-level formatting. It is interesting to note that the FORMAT utility will perform both low-level and high-level formatting for a floppy disk, but not for a hard drive.

Optical Disk Drives

Optical disk drive works on the principle of optics. The optical disk drive is used to read and write digital data on compact disks (CD), Digital versatile disc (DVD) and blue ray disks. This is one device that can be used as both input (read data in) and output device (writes data out). It is connected to motherboard via IDE (ATA), SCSI, S-ATA, Firewire, or USB interface. Its DATA WRITING OR BURNING speed rate is 1x, 4x, 8x, 12x, 24x, 48x, 52x. The various types of optical drive are:

CD-ROM: Stands for Compact Disc Read Only Memory. Users can read data from the CD but cannot burn/write their information on CD

CD-WRITER: Users can read and write data to and from the CD

DVD-ROM: Users can only read data from the CD and DVD

DVD-WRITER: Users can read and write data from both CD and DVD

External drives

Memory Stick

Memory Stick is a type of flash memory developed by Sony. It is used to store data for digital cameras, camcorders, and other kinds of electronics.

Memory Stick cards are available in two versions: Memory Stick PRO and Memory Stick PRO Duo. Memory Stick PRO cards are 50mm long by 21.5mm wide and are 2.8mm thick. Memory Stick PRO Duo cards are 31mm long by 20mm wide and are only 1.6mm thick. High-speed versions of Memory Stick media support data transfer rates up to 80Mbps, or 10 MB/sec, which is fast enough to record high-quality digital video.

The data on the memory stick is stored in a digital format. The solid-state chip inside the card's plastic cover contains many tiny electrical circuits. When the card is not in use, the circuits retain their charges without any additional power. When a card is placed in an activated device, such as a camera or a cellphone, a small electrical current from the device moves electrons in the flash memory chip. The digital patterns stored on the chip correlate to the data stored there. Data is erased when a slightly higher voltage is applied to the circuit. This allows for rewriting data in the card again.

USB flash drive

A USB flash drive is a device used for data storage that includes a flash memory and an integrated Universal Serial Bus (USB) interface. Most USB flash drives are removable and rewritable. Physically, they are small, durable and reliable. The larger their storage space, the faster they tend to operate. USB flash drives are mechanically very robust because there are no moving parts.

The main components of the USB flash drive are:

- Standard USB plug. This provides connects the flash drive to a device.
- USB mass storage controller. This is a microcontroller for the USB. It has a small amount of RAM and ROM.
- NAND flash memory chip. The data is stored in the this component
- Crystal oscillator. The data output is controlled by this component.

SSD

SSD stand for Solid State Drive. It is a storage medium that uses non-volatile memory to hold and access data. Unlike a hard drive, an SSD has no moving parts, which gives it advantages, such as faster access time, noiseless operation, higher reliability, and lower power consumption. The picture shows an example of an SSD. Internal SSDs connect to a computer like a hard drive, using standard IDE or SATA connections. **SSD** uses semiconductor chips, not magnetic media for storing data.

SSDs have traditionally used the SATA connection, which has a theoretical maximum transfer rate of 750 MB per second. Newer generations of SSDs connect to the motherboard's PCIe connection, offering speeds of up to 1.5 GB per second. The PCIe M.2 connection standard, introduced in 2014, offers a maximum real-world throughput of approximately 4 GB/s.

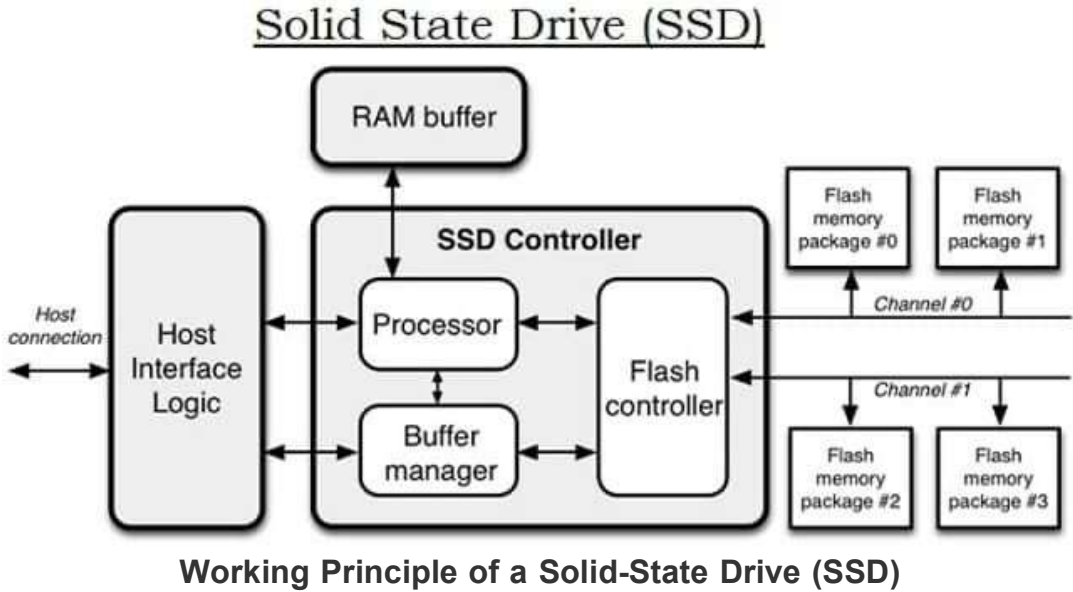

Types of Solid State Drive (SSD)

SSDs can be classified by different form factors such as the type of connections. Some are listed below:

- **SATA III:** The connection works with the final evolution of an older option which works with both the Solid State Drives and the Hard Disk Drives. This is a smaller driver and a bare circuit. These are used in smaller capacity usually found in notebooks or laptops.
- **PCIe:** Peripheral Component Interconnect Express option connects directly to the motherboard for a direct flow of data which in turn supports the SSD writing speeds to around 1GB per second. As the interface, the SSDs use the PCI-E slot which makes limits the speed of the PCI-E slot.
- **M.2 SSD:** These are similar to mSATA with the concept of having a bare circuit board. The difference compared to the other SSD is that within the M.2 form factor there are a variety of different width and length combinations which brings in more flexibility in its usage. These types of SSDs are typically used for mobile solutions such as ultra-books or tablets.
- **NVMe (Non-Volatile Memory Express):** NVMe are the versatile PCIe connections which are easier to upgrade and generally faster. It's a communication interface which defines a command set.

Advantages of Solid-State Drive (SSD)

- **Durability** – Being more rugged and heavy duty, a SSD covers a very high number of drive cycles.
- **Speed** – The speed accessed by the SSD is 35 to 100 micro-seconds, which is 100 times the performance of HDDs. SSD can improve the online presence when it comes to hosting a website. This is due to the faster website loading speed and stable and efficient data storage.
- **Availability in the Market** – SSDs are available in various physical and memory sizes.
- **Low Power Consumption** – Compared to the HDD, a SSD consumes less power since they don't have any moving parts.

Disadvantages of Solid State Drive (SSD)

- **Cost** – SSDs are more expensive than the HDD even after having similar storage capacity.
- **Data Recovery** – The data can be completely destroyed and cannot be recovered if one of the memory flash is destroyed.
- **Storage** – SSD faces a major problem regarding the storage. The data can be written on empty blocks. However, when the blocks get filled, overwriting becomes an issue. Reading the data is not affected by this. To avoid this issue, one has to transfer the data into another memory drive and erase the SSD to reload the data.

Key Board

A computer **keyboard** is one of the primary input devices used with a computer. Similar to a typewriter, a keyboard is composed of buttons that create letters, numbers, and symbols, as well as other functions.

The keyboard's design comes from the original typewriter keyboards, which arranged letters and numbers in a way that prevented the type-bars from getting jammed when typing quickly. This keyboard layout is known as the QWERTY design, which gets its name from the first six letters across in the upper-left-hand corner of the keyboard.

While the design of computer keyboards may have come from typewriters, today's keyboards have many other keys as well. Modifier keys, such as Control, Alt/Option, and Command (Mac) or the Windows key (Windows) can be used in conjunction with other keys as "shortcuts" to perform certain operations.

Most of today's computer keyboards also have a row of function keys (F1 through F16) along the top of the keyboard, arrow keys arranged in an upside-down T, and a numeric keypad on the right-hand side. Some keyboards have even more buttons, allowing you to change the system volume, eject a CD, or open programs such as your e-mail or Web browser.

Key Board connector

There are three type of connectors for connecting the keyboard to motherboard. The interfaces are mounted on the back panel of the motherboard. They are 5-PIN DIN, 6-PIN MINI DIN or PS/2 and USB



5-Pin DIN



**6-Pin
Mini DIN**



5-PIN DIN is the oldest keyboard connector. It was used in AT and baby AT type motherboard. The mother board has female connector and the key board has the male connector.

PIN 1: Used for Keyboard Clock

PIN 2: used for Keyboard data

PIN 3: Unused

PIN 4: Ground

PIN 5: +5v Power

6-PIN MINI DIN is also known as PS/2 connector. This is used in ATX, LPX and NLX motherboards. Pointing devices like Mouse can also connect to it. So all the motherboards have two number of PS/2 port. One is for Keyboard and the other is for Mouse.

PIN 1: Key Board Data

PIN 2: Unused

PIN 3: Ground

PIN 4: +5V Power

PIN 5: Keyboard clock

PIN 6: Unused

USB type is newly developed interface where we can connect the keyboard. All the latest motherboards have this type of facility. To run a USB Keyboard the BIOS must support it. Otherwise it will work in graphical mode only and it cannot run in DOS mode. This means the BIOS must have facility to enable the option of "USB Keyboard".

A **wireless keyboard** can be connected using RF technology with the help of two parts, a transmitter and a receiver. The radio transmitter is inside the **wireless keyboard**. The radio receiver plugs into a **keyboard** port or USB port. Bluetooth is another technology that is being widely used by wireless keyboards. These devices connect and communicate to their parent device via the Bluetooth protocol.

Key Bouncing

Mechanical switches are used as **keys** in most of the keyboards. When a **key** is pressed the key contact the circuit and **bounce** back upward and then settle down only after a small time delay (about 20ms). Even though a **key** is activated once, it will triggered several times. This problem is called **Key Bouncing**.

Mouse Interfaces

To transmit their input, typical cabled mice use a thin electrical cord terminating in a standard connector, such as RS-232C, PS/2, ADB or USB. Cordless mice instead transmit data via infrared radiation or radio (including Bluetooth), although many such cordless interfaces are themselves connected through the aforementioned wired serial buses.

Mouse use in DOS applications became more common after the introduction of the Microsoft mouse, largely because Microsoft provided an open standard for communication between applications and mouse driver software.

Serial interface and protocol

Standard PC mice once used the RS-232C serial port via a D-subminiature connector, which provided power to run the mouse's circuits as well as data on mouse movements.

PS/2 interface and protocol

With the arrival of the IBM PS/2 personal-computer series in 1987, IBM introduced the PS/2 interface for mice and keyboards, which other manufacturers rapidly adopted. The most visible change was the use of a round 6-pin mini-DIN, in lieu of the former 5-pin connector.

USB

The industry-standard USB (Universal Serial Bus) protocol and its connector have become widely used for mice; it's currently among the most popular types.

Cordless or wireless

Cordless or wireless mice transmit data via infrared radiation or radio (including Bluetooth). The receiver is connected to the computer through a serial or USB port, or can be built in (as is sometimes the case with Bluetooth). Modern non-Bluetooth wireless mice use USB receivers.

Printers

A printer is an output device that prints paper documents. This includes text documents, images, or a combination of both. The printed output produced by a printer is called a hard copy, which is the physical version of an electronic document. World's first computer printer was a 19th-century mechanically driven apparatus invented by Charles Babbage. There are two types of printers. Major types of printer Printers can be divided into two main groups, impact printer and non- impact printer.

Impact printer: *Impact printer produces text and images when tiny wire pins on print head strike the ink ribbon by physically contacting the paper.*

Non-Impact printer: *Non-impact printer produces text and graphics on paper without actually striking the paper.*

Daisy-Wheel Printers

In order to get the quality of type found on typewriters, a daisy-wheel impact printer can be used. It is called daisy-wheel printer because the print mechanism looks like a daisy; at the end of each "Petal" is a fully formed character which produces solid-line print. A hammer strikes a "petal" containing a character against the ribbon, and the character prints on the paper. Its speed is slow typically 25-55 characters per second.

Drum Printer

A drum printer consists of a solid, cylindrical drum that has raised characters in bands on its surface. The number of print positions across the drum equals the number available on the page. This number typically ranges from 80-132 print positions. The drum rotates at a rapid speed. For each possible print position there is a print hammer located behind the paper. These hammers strike the paper, along the ink ribbon, against the proper character on the drum as it passes. One revolution of the drum is required to print each line. This means that all characters on the line are not printed at exactly the same time, but the time required to print the entire line

is fast enough to call them line printers. Typical speeds of drum printers are in the range of 300 to 2000 lines per minute.

Dot-Matrix Printers

The dot-matrix printer uses print heads containing from 9 to 24 pins. These pins produce patterns of dots on the paper to form the individual characters. The 24 pin dot-matrix printer produces more dots than a 9 pin dot-matrix printer, which results in much better quality and clearer characters. The general rule is: the more pins, the clearer the letters on the paper. The pins strike the ribbon individually as the print mechanism moves across the entire print line in both directions, i.e., from left to right, then right to left, and so on. The user can produce a color output with a dot-matrix printer (the user will change the black ribbon with a ribbon that has color stripes). Dot-matrix printers are inexpensive and typically print at speeds of 100-600 characters per second.

Ink-Jet Printers

Ink-jet printers work in the same fashion as dot-matrix printers in the form images or characters with little dots. However, the dots are formed by tiny droplets of ink. Ink-jet printers form characters on paper by spraying ink from tiny nozzles through an electrical field that arranges the charged ink particles into characters at the rate of approximately 250 characters per second. The ink is absorbed into the paper and dries instantly. Various colors of ink can also be used.

Laser Printer

It is a type of printer that utilizes a laser beam to produce an image on a drum. The light of the laser alters the electrical charge on the drum wherever it hits. The drum is then rolled through a reservoir of toner, which is picked up by the charged portions of the drum. Finally, the toner is transferred to the paper through a combination of heat and pressure.

The available resolutions range from 300 dpi at the low end to 1,200 dpi at the high end. In addition to text, laser printers are very adept at printing graphics, so you need significant amounts of memory in the printer to print high-resolution graphics.

General troubleshoot printer issues

- **Printer does not have power supply**
- **Data & power cables not connected properly**
- **Printer error (orange or blinking light)**
- **No paper or paper jam**
- **Inkjet printer ink related issues**
- **Printer self-tests process**

Scanner

A scanner is an input device that scans documents such as photographs and pages of text. When a document is scanned, it is converted into a digital format. This creates an electronic version of the document that can be viewed and edited on a computer.

Most scanners are flatbed devices, which means they have a flat scanning surface. This is ideal for photographs, magazines, and various documents. Most flatbed scanners have a cover that lifts up so that books and other bulky objects can also be scanned. Another type of scanner is a sheet-fed scanner, which can only accept paper documents. While sheet-fed scanners cannot scan books, some models include an automatic document feeder, or ADF, which allows multiple pages to be scanned in sequence.

Scanners work in conjunction with computer software programs, which import data from the scanner. Most scanners include basic scanning software that allows the user to configure, initiate, and import scans. Scanning plug-ins can also be installed, which allow various software programs to import scanned images directly. Scanners come in many shapes and sizes. The various scanner types are

Flatbed Scanners

Flatbed scanners are the scanners that most people are familiar with. These scanners sit on your desk with a flip-up top that reveals the scanning glass when open. They come in a couple of different sizes for standard paper or up to legal sized and beyond. You may also find all-in-one models that include a scanner and a printer,

minimizing the amount of desk space required. Flatbed scanners are excellent for scanning newspaper articles, books, and even DVD cases for those who wish to digitize their movie library.

Sheet fed Scanners

Sheet fed scanners are ideal if you need to scan large volumes of documents. They are a bit smaller than standard flatbed scanners making them great if you are working with limited space. Most sheeted scanners have a lower image resolution than flatbeds, but for documents this is not a major concern. The big advantage here is the ability to scan several documents at a time rather than have to manually change pages after each scan. Documents can be loaded into a feeder tray and the machine will pull in one page at a time for scanning, much like a photocopier.

Photo Scanners

Photo scanners are exactly what they sound like and are best suited for you if you need to digitize a large volume of photographs and negatives. They can be considerably more expensive than all-purpose scanners, but the difference in quality and resolution. Photo scanners usually come with their own specialized photo editing software and also adapters that allow you to work with negatives and slides.

Portable Scanners

Portable scanners are tiny little handheld devices or small tabletop devices that allow you to scan anything, anywhere, any time. Some are no bigger than an ink pen, while higher quality portable scanners will be a bit larger. Most portable scanners will not give as high of a resolution as a flatbed scanner.

Film and Slide Scanners

For high quality scans of 35mm film, negatives or slides you will probably be happiest with a higher end photo scanner. But there are small slide scanners available specifically for bulk scanning of film products. The image quality won't be as good

General scanner troubleshooting

- Verify cables connected properly to the back of the scanner
- Ensure that the scanner is getting power
- Verify the parallel port of scanner functioning properly
- Update the drivers

Display

The display device is an output device used to represent the information in the form of visual form may be text and graphics. Display systems are mostly called a **video monitor** or **Video display unit (VDU)**. **The display unit is classified into various categories. These as follows:**

1. **Cathode-Ray Tube (CRT)**
2. **Liquid crystal display (LCD)**
3. **Light Emitting Diode (LED)**
4. **Plasma Display**
5. **Thin-film transistor (TFT)**

Pixels: The term that comes from the words **PEL (picture element)**. A **px (pixel)** is the smallest portion of an image or display that a computer is capable of printing or displaying.

Cathode-Ray Tube (CRT)

Here, CRT stands for Cathode ray tube. It is a technology which is used in traditional computer monitor and television. Cathode ray tube is a particular type of vacuum tube that displays images when an electron beam collides on the radiant surface.

In the CRT are three electron guns: red, green, and blue. Each of these guns streams a steady flow of electrons, left to right, for each line of your monitor. As the electrons hit the phosphors on the CRT, the phosphor will glow certain intensities.

Liquid crystal display (LCD)

LCD is a flat display technology used in laptops, cell phones, calculators, digital cameras, and flat screen displays. The LCD is made of two sheets of a flexible polarizing material and a layer of liquid crystal solution between the two. An LCD is available as an active-matrix, dual-scan, or passive-matrix display and are most common with laptop. An LCD does not refresh like a CRT monitor. Instead, a picture is created by sending electricity through liquid crystals which untwist at the rate of electricity applied, creating 64 shades.

A **passive-matrix display**, is an LCD with a row of transistors running horizontally (x-axis) and vertically (y-axis). The amount of transistors are defined by the LCD manufacturer. Unfortunately, if one of these transistors were to fail, you would receive a solid black line going vertical or horizontal.

An **active-matrix display** is an LCD (liquid crystal display) introduced with the IBM ThinkPad in 1992. With Active-matrix displays, each pixel is controlled by one to four transistors that make the screen brighter and more colorful than passive-matrix displays. Active-matrix displays also update the screen faster than passive-matrix displays and are capable of being viewed at a greater viewing angle.

Light Emitting Diode (LED)

LED is a semiconductor that illuminates when an electrical charge passes through it. LEDs are commonly green, amber, or red, but they can be now available in various colors.

A **LED display** is a flat panel display that uses an array of light-emitting diodes as pixels for a video display. Currently, a large number of electronic devices, both small and large, use LED display as a screen and as an interaction medium between the user and the system. Modern electronic devices such as mobile phones, TVs, tablets, computer monitors, laptops screens, etc., use a LED display to display their output.

Plasma Display

A **plasma** display is a **computer** video display in which each pixel on the **screen** is illuminated by a tiny bit of **plasma** or charged gas, somewhat like a tiny neon light. **Plasma** displays are thinner than cathode ray tube (CRT) displays and brighter than liquid crystal displays (LCD). Each plate contains a conductive print; one is horizontal, and the other is vertical. These displays ranged from 42 to 60-inches

Thin-film transistor (TFT)

A **thin-film-transistor liquid-crystal display (TFT LCD)** is a variant of a liquid-crystal display (LCD) that uses thin-film-transistor (TFT) technology to improve image qualities such as addressability and contrast. A TFT LCD is an active-matrix LCD. The TFT technology provides the best resolution of all the flat-panel techniques, but it is also the most expensive. TFT screens are sometimes called *active-matrix LCDs*.

The benefit of thin-film transistor technology is the separate, tiny transistor for each **pixel** on the display. Because each transistor is so small, the amount of charge needed to control it is also small. This allows the screen to refresh very quickly, as the image is re-painted or refreshed several times per second.

SMPS - Switch Mode Power Supply

The term SMPS is defined as when the power supply is involved with the switching regulator to change the electrical power from one form to another form with required characteristics is called SMPS. This power supply is used to achieve regulated DC output voltage from the DC input voltage (or) unregulated AC. SMPS is a complex circuit such as other power supplies, it provides the supply from a source to the loads. SMPS is very important for different appliances which consume power and also for making electronic projects

Input rectifier stage

In this stage the AC input is convert into the DC. This is called RECTIFICATION. A SMPS with a DC input does not require this stage.

In computer ATX power supply (SMPS), the rectifier circuit can be configured in such a way that it can double the voltage level by the addition of a switch operated either manually or automatically. This feature permits operation from power sources that are normally at 115 V or at 230 V. The rectifier produces an unregulated DC voltage which is then sent to a large filter or capacitor.

Inverter stage

The inverter stage converts DC, whether directly from the input or from the rectifier stage to AC by running it through a power oscillator, whose output transformer is very small at a frequency of tens or hundreds of kilohertz

Voltage converter and output rectifier

If the output is required to be isolated from the input, as is usually the case in mains power supplies, the inverted AC is used to drive the primary winding of a high-frequency transformer. This converts the voltage up or down to the required output level on its secondary winding. The output transformer serves this purpose.

If a **DC** output is required, the **AC** output from the transformer is rectified. For output voltages above ten volts or so, ordinary silicon diodes are commonly used. For lower voltages, Schottky diodes are commonly used as the rectifier elements. The rectified output is then smoothed by a filter consisting of inductors and capacitors.

Output Voltages of SMPS

+5 Volt Supply: This is the basic supply voltage for nearly all electronic components. The +5 volt supply wires should always be red in any standard PC system.

+12 volt Supply: the main function of the +12V power is to run disk drive motors as well as the higher output processor voltage requirements in some of the newer boards. +12V supply is used by any cooling fans in the system.

-12Volt Supply: This voltage can be used by any add-on card plugged into the ISA bus slots, usually only the serial port driver/receiver circuits use it for converting TTL signals. In a modern PC the -12V is left unused.

-5Volt Supply: It is directly rounded to the ISA bus pin B5 for use by add on cables. In earlier floppy drive controller cards; the analog data separator circuit used-5V.

+3.3 Volt Supply: It is used in the ATX type SMPS to provide 3.3 volt supply to the motherboard. Most CPUs and DRAM use 3.3 volts, and some PCI adapter cards are also used 3.3 volt. All high speed PCI adapter cards to use 3.3 volts for all communications with the PCI Bus.

+3.3 Sense: it is used to sense the actual voltage of the 3.3 volt supply after it has reached the motherboard, which allows the power supply to actively adjust the 303 volt output to compensate for line losses between the power supply and the motherboard.

Power Good: The Power Good signal is also known as Power OK signal. Its purpose is to ensure that the computer is functioning properly with the power supply and the computer can continue to operate normally. If the Power-Good signal is not present at start-up, the CPU will not start function. If a Power-Good signal goes down during operation, the CPU will shut down. The Power-Good signal prevents the computer from attempting to operate on improper voltages and damaging itself. Once this signal is received from the supply, the motherboard can begin its POST and boot process.

SMPS advantages

- High efficiency:
- Compact:
- Flexible technology:

SMPS Disadvantages

- Noise
- External components
- Expert design required
- Costs

Assembly of Desktop Computers

1. Planning Your Computer: This is a key factor that effects the selection of a computer. Before buying any computers, you'll need to know what you plan on using the computer for.

2. Components need to buy: Processor, Motherboard, RAM, Hard Drive or SSD, Power, Case, Graphics Card (optional), Cooling system

3. Ground yourself: Use an antistatic wrist-strap cable to prevent electrostatic discharge (ESD) which can be deadly to computer electronics. Alternatively, touch a large metal body like a radiator to discharge yourself.

4. Open the case: Unscrew the side panel (or slide it toward the back of the case) to do so.

5. Install the power supply. Some cases come with the power supply already installed, while others will require you to purchase the power supply separately and install it yourself. Make sure that the power supply is installed in the correct orientation, and that nothing is blocking the power supply's fan

6. Connect the CPU to the Mother Board: Attach the processor to the motherboard by finding the processor port on the motherboard's surface. An indicator on CPU and motherboard will show you the correct orientation. Apply thermal paste to the processor if necessary and attach the heat sink with cooler on top of the CPU.

7. Connect RAM: Attach the RAM to the motherboard by finding the RAM slots and inserting the RAM appropriately (they should only fit one way).

8. Install the motherboard: Once the standoffs are installed, place the motherboard in the case and push it up against the back plate. All of the back ports should fit into the holes in the I/O back plate. Use the screws provided to secure the motherboard to the standoffs through the shielded screw holes on the motherboard.

9. Plug in the case connectors. These are likely to be located on the motherboard near the front of the case. The order in which these are connected will depend on manufacturer. So the Mother Board manual must be followed while connecting these ports.

Make sure that you connect the USB ports, the Power and Reset switches, the LED power and hard drive lights, and the audio cable.

There is typically only one way that these connectors can attach to the motherboard. Don't try to force anything to fit.

10 Install your hard drive. This process will vary slightly depending on your case, but should typically go as follows:

- Remove any front panels on the case (if you're installing an optical drive, you will usually install it near the top of the case).
- Insert the hard drive into its slot (usually near the middle of the case from inside only).
- Tighten any screws needed to hold the drive in place.
- Plug the hard drive's SATA/PATA cable into the SATA/PATA (IDE PORT) port on the motherboard.

11. Connect the power supply to any necessary components. Make sure that Power Supply must be connected to Motherboard, Hard drive or SSD, Optical drive and other components if necessary.

12. Finish your computer assembly: Once you've placed and connected the various internal components for your computer and connected various cables including power supply and data cable, the installation is finished and close the cover of the case and tighten the screw properly.

13. Provide Power Supply: Connect one end of a power supply cable to SMPS and the other end is plug into a wall outlet power supply and switch on the computer.

14. Connect Display Unit: Connect a LCD or a CRT monitor to the computer using a VGA cable and provide power supply to the monitor.

15. Connect Key Board and Mic: Connect Key Board and Mice to the computer properly using back panel ports and also connect other I/O devices if necessary.

If everything is connected properly than the computer will start functioning properly without any problem.

Configuring Laptops and Power settings

When purchasing a laptop directly from a manufacturer, such as Dell, Lenovo or HP, you often have the option to configure your system with your choice of CPU, screen, memory, storage and other key components. Here's a summarized version of our laptop buying guide that breaks down all the different components.

CPU: Go for Core i5

When it comes down to choose a CPU, you should choose a CPU for the best balance of performance and price and the best one is CORE i5. For budget laptops, a Core i3 chip will provide remarkably better performance than a Pentium or Celeron.

RAM: Roll with 8GB

It has been already tested that a 8GB of RAM has a good multitasking and high productivity facility. More the RAM size greater the performance of the laptop. Hardcore multitaskers and gamers will benefit from 16GB.

Storage: 256GB SSD or better

If possible, a solid-state drive (SSD) is preferred rather than a hard drive, because the SSD offers a much faster, more responsive system. If you don't need to keep a lot of media files or PC games on your storage drive, you can use a 256GB SSD, rather than a more-expensive 512GB model.

Screen: At Least 1920 x 1080 resolution

A full 66 percent of consumer laptops come with low-resolution screens, most of which are 1366 x 768 pixels. At that resolution, you'll have to do a ton of scrolling and window switching, because you can't fit much text on the display at once and can't stack full windows side by side. So the display screen should not be less than 1920 x 1080 (1080p) resolution for HD performance.

Battery: Bigger is better

The battery type of a laptop is a great issue. Other than the business model most of the laptop comes with low power battery type. If the battery power is more the laptop will function more hours compare to low power battery.

Wi-Fi Card: 2x2 is better

In a laptop Wi-Fi is highly essential. Now all the laptops have 802.11ac Wi-Fi, which is the current standard of Wi-Fi. If a card is labeled as 2x2, it has two antennas, each of which can carry its own data stream. On a standard 802.11ac network, a 2x2 card can transfer at a rate of up to 867 Mbps, while a 1x1 card tops out at 433 Mbps.

Windows Version: Don't go Pro

Some companies will give you a choice of Windows 10 Home or Pro when you're configuring your laptop. While Windows 10 Pro offers extra features such as remote desktop, BitLocker encryption and group policy manager. Most of these extras are useful only for a large businesses with IT departments. So, Pro is not worth with an extra cost of Rs.10000 or more.

4G Cards: Only for deep pockets

A few laptops allow you to get a built-in, 4G LTE card so you can stay connected on the road. However, you'll have to pay extra cost more than Rs.20000/- + data usage charges extra. If you rely on your laptop for business, having built-in 4G is a nice convenience, but it's probably cheaper to just use your phone as a hotspot and connect to it.

Bottom Line

Unless you're buying a really inexpensive laptop, go for a 1080p screen, a Core i5 CPU, at least 8GB of RAM and an SSD that has 256GB or more.

Speakers: Preferred Dolby Digital Sound

Laptops have the built in speakers and those speakers are at the right and the left side of the laptop. One can easily find them on the laptop. The speaker quality varies in some laptops and normally, they are the same.

I/O Ports

A Laptop must have a standard Keyboard, USB-3-0, Bluetooth VER.5 or higher, Audio and Mic Combo Port, HDMI, USB-C Port, Card reader Port and RJ45 port (optional)

Power settings in Laptop

In a Laptop It is essential that, manage the power properly for a better performance. Windows operating systems provides many options to manage the laptop's power settings.

Power options can be set to a pre-configured Windows settings, or customize the settings according to user's need. Depending on the operating system, the choices may be: Hibernate, Sleep or various custom settings.

The best power settings balance energy use and productivity. When on battery, configure the laptop power to reduce display brightness and to go into Sleep mode when idle. For best results, it is advised to shut off the display after idle for 15 to 20 minutes, and shut off or set Sleep mode for the hard drive after idle time reaches 20 to 30 minutes.

Laptop Components

Adapter: It is a power supply unit for electronic devices. Also called an "AC adapter" or "charger," power adapters plug into a wall outlet and convert AC voltage to a DC voltage. Computers use multiple DC voltages, and the power adapter is the external part of the power supply for a laptop.

Battery: It is used to provide power backup in order to operate laptop when AC mains power is not available. The common laptop battery voltages are 10.8V, 11.1V or 14.8V. All the laptop batteries are rechargeable. The common laptop battery types include lithium ion (i.e., Li-ion), nickel cadmium (i.e. NiCad) and nickel metal hydride (i.e. NiMH). Out of these Li-ion is being most commonly found in latest laptops. They are made using various combination of cells like 3 cells or 4 cells etc.

RAM types: RAM is the short form of Random-Access Memory. It is the type of memory which can be accessed randomly. It is temporary memory which stores data and Laptop uses SO-DIMM (**small outline dual in-line memory module. SO-DIMMs are a smaller alternative to a DIMM, being roughly half the size of regular DIMMs.**) DDR SDRAM types which are double data rate synchronous dynamic random-access memory (RAM) class of memory ICs. The common types of SDRAM include DDR1, DDR2, DDR3 and DDR4.

CPU types: Laptop processors are different from the desktop counterparts because the laptop processor must have to run the laptop when the laptop is not plugged into an outlet. So it consumes limited amount of power.

Most laptop users don't need high-end processors to run productivity software, but for PC gaming and video editing, you'll need a powerful CPU in addition to sufficient RAM and a dedicated video card. The less power the laptop uses, the longer the system can run on the battery.

Laptop Motherboard & block diagram: A laptop **motherboard** is the primary printed **circuit board** (PCB) inside the laptop that contains the components that make the computer work.

Significantly the Laptop mother boards are thinner and smaller than a desktop. With a smaller motherboard, the components must be closer together. A poorly designed motherboard could cause problems with heat build-up or interference between components.

Laptop motherboards also might have an odd shape or several notches, allowing them to fit inside the thin laptop case, along with other necessary components.

The laptop motherboard might not have any expansion slots, while a desktop board might have five or more. Rather than using expansion slots and expansion cards for items like **sound cards** or networking, a laptop motherboard would include those components directly on the motherboard, and they're called integrated components.

Laptop Keyboard:

A typical **laptop keyboard** layout has typewriter keys, shift keys, function keys, and cursor control keys. These include Shift, Alt, Ctrl, and the special Windows keys Win and Context. The Win key appears in the bottom row between the Fn and Alt keys; the Context key appears between Alt and Ctrl.

The below figure illustrates a typical laptop keyboard layout, where all the common keys found on the whopping desktop keyboard have been miniaturized to laptop size. The design intends to let you type without the risk of fire from your fingers rubbing together.

- **Alphanumeric, or "typewriter," keys:** These are the basic typing keys, each of which is labeled with a character (a letter, number, or punctuation symbol). When you're typing on the computer, pressing a key produces its character on the screen.
- **Shift keys:** The keyboard sports various shift keys used either alone or in combination with other keys. These include Shift, Alt, Ctrl, and the special Windows keys Win and Context. The Win key appears in the bottom row between the Fn and Alt keys; the Context key appears between Alt and Ctrl.
- **Function keys:** These keys are labeled F1 through F12 and are found on the top row of the keyboard, right above the number keys.
- **Cursor-control keys:** These keys can be anywhere around the keyboard, although in this example, they're on the top and bottom right. They include the four directional arrow keys, usually found in an inverted T pattern, as well as the Insert (or Ins), Delete (or Del), Home, End, PgUp (or Page Up), and PgDn (or Page Down) keys.

Maintenance

The computer is a machine having electrical and electromechanical peripherals. For a longer life of the computer, it needs maintenance periodically. Basically, there are three types of maintenance.

Preventive Maintenance:

- Preventive maintenance (PM) is a series of maintenance carried out to prevent system problems. It can be done as a precautionary measure to avoid any problem in future.

- Preventive maintenance includes PC components such as, mouse, keyboard, drives, and monitor to ensure smooth functioning of a PC.
- Preventive maintenance can be carried out as per the manufacture's guide line using appropriate cleaning materials. Some common problems those must be taken care as a Preventive maintenance are:
 - **Dust Proofing:** Dust may damage HDD, FDD, RAM and other components of a computer. So precaution should be taken by cleaning the room and other equipment regularly.
 - **High temperature:** It causes data loss, intermittent problem and early failure of electronic components. Precaution should be taken by providing sufficient cooling and air circulation.
 - **Electrical Noise:** It causes break down of the various circuit and signals. Precaution should be taken by shielding cables, using isolation circuit etc.
 - **Magnetic fields:** Affects data recorded in a floppy disk. Precaution should be taken by keeping the PC from Audio speaker and TV.
 - **Power Fluctuations:** Causes unreliable operation and damage of electronic components. . Precaution should be taken by using CVT, Surge suppressor, isolation circuit etc.
 - **Improper handling:** Corruption of disk & data, damage of key switch of key board. . Precaution should be taken by handling the computer properly and safely.

Preventive maintenance provides the following benefits:

- It saves by reducing the possibility of a sudden breakdown of the PC and the other associated components.
- **It saves time as** troubleshooting the components and their repair procedures take more time as compared to preventive maintenance procedures.
- **It safeguards the data by protecting Hard Disk drive.**
- **It improves performance** and life of the computer and other components

Corrective Maintenance:

- Corrective maintenance is a type of system maintenance which is performed after a fault or problem appears in a system. Corrective maintenance process is used for diagnosing and fixing existing problems.
- Corrective maintenance may require repairing parts or even replacing them with new ones. Computer technicians are specifically trained to carry out the corrective maintenance process.
- The diagnostic process can include a physical inspection of a system, the use of a diagnostic computer to evaluate the system, interviews with system users, and a number of other steps.
- After diagnosis the next step is repair or replacement of damaged components or software.

Online Maintenance:

- In Online computer Maintenance process a user will get help to repair the computer through online process like Telephonic call or through Internet.
- Hardware breakdown problem can be solved quickly through the online service & support center of the manufacturer.
- Most of the software problem can be solved through online maintenance process by updating various software and operating system security patches.

- If the system is running slow than the online support site can run a lot of tests on our system to diagnose the problem and solve the problems by installing some update patches.

Now a day this is the most popular way to get the support. It saves time and money. Few examples of the online Computer repair are:

- They can schedule the online scan of the system as per the user's requirement.
- They can update the system patch level online so the system keeps running smoothly.
- They can keep watching on the hardware status logs so it can be repaired in case of need.
- They can keep the track of the performance of the computer.
- They can keep the record of the system security and clean the unwanted files and defends the virus attacks.
- The online computer repair is the future of the computer support.

Troubleshooting

Troubleshooting in a computer is an intelligent and sophisticated process. A wide variety of computers are available in the market. So before troubleshooting it is highly recommended that user's manual should be carefully followed. Successful troubleshooting depends on the following factors. They are:

1. Problem solving approach.
2. Techniques applied in troubleshooting.
3. Tools and test equipment used.
4. Diagnostic support in the PC.

A fault in a computer system affects the normal operation of the computer. The following are some computer faults that usually we are facing.

1. A program has given a wrong result
2. A program is looping continuously.
3. The CPU not working properly.
4. There is a junk display in the monitor.
5. The printer starts printing suddenly without any print command.
6. The Floppy disk drive or CD-Drive always remains selected.
7. The hard disk drive not reading.

Nature of Faults

Computer faults can be broadly divided into two types. They are as follows.

1. Permanent fault:

If the computer misbehaves consistently than we can say it is a permanent fault. For example any number of times the program run, the results or the symptoms are same.

2. Intermittent fault:

If the computer's behavior is not consistence than the problem is known as intermittent problem. In this type of problem the computer will suddenly starts malfunctioning. After a certain time, it recovers from the fault automatically and again starts functioning properly.

Types of faults

Generally, there are two types of computer fault. They are:

1. Hardware fault:

A hardware fault can occur at any time due to electronic problem, mechanical problem, environmental problem and media problem. All type of hardware problem may be both solid and intermittent problem. It is easy to find a solid problem but it is very difficult to find an intermittent problem.

2. Software fault:

The software problem may occur in a computer like some programs may not work properly or it may work for certain type of data. These problems are happening because of the software is not proven, tested and debugged properly.

Diagnostic programs and Tools:

Diagnostic Program:

- The diagnostic program is a special type program which is provided by the manufacturer. This program is designed to verify the various functions of computer hardware.
- A hardware problem can be detected by running these programs. To identify an intermittent problem it is necessary to run the diagnostic program multiple times. It also helps to identify the problem of both hardware and software.

The various Diagnostic programs are:

- **Microsoft Diagnostics:** Better known as "MSD.EXE", this is a small DOS utility that takes a brief inventory of the contents of the PC and shows the result in a text-based format.
- **Microsoft Scandisk and Norton Disk Doctor:** These programs are used to check for hard disk problems. This includes file system corruption and hard disk read errors. They should be used when hard disk problems are suspected.
- **Norton Diagnostics:** This utility is meant to go beyond the System Information program and actually perform tests on the hardware to identify problems. It includes tests of the processor and motherboard and system memory, and will identify some types of resource conflicts.

Various tools:

There are two types of troubleshooting tools:

1. Nodal Testers
2. System Testers

The nodal testers are simple conventional test equipment used to probe in and around the faulty circuit. These testers include logic probe, logic pulsar, current tracer and oscilloscope.

Logic probe: Logic probe is a hand-held low-cost test equipment through which ninety percent of the fault can be diagnosed. It is used to find out the logic state of any node in a circuit including steady states and pulses.

Logic pulsar: The logic pulsar is a hand-held tool used to inject pulses at the input of a logic gate. The user can use a single pulse or a stream of pulses at different frequencies.

Current tracer: It is a hand-held tool which detects current flow in electronic circuits. It is useful shorted components, track shorts, solder bridges, etc.

Oscilloscope: An oscilloscope helps to reserve all most any problem in a PC. This tool includes three levels of testing. They are:

1. To test logic levels.
2. To measure signal characteristics such as frequency, pulse width, raise and fall time, noise, etc.
3. To measure the timing relationship between two or more signals.

System testers: The system tester is a sophisticated test tool which is used to isolate the faulty sub system quickly. The system testers include emulators, functional testers, logic analyzer, etc.

Fault elimination process:

Fault finding is a technique. Sometimes even simple problems cannot be traced in a reasonable amount of time. A service engineer should learn the techniques of trouble shooting and fault finding techniques. Some of the common elimination steps are:

1. Check the AC input voltage. The voltage must be within the specification of the computer.
2. The voltage difference between the ground and neutral should be less than 6v.

3. Check the DC output voltage of the SMPS.
4. Check whether all cables are installed properly.
5. Check for loose contact in any connectors.
6. Check whether the cooling fan inside the SMPS is working.
7. Check dust sensitive areas like FDD, optical drive, etc.
8. Inspect for any broken components like resistors, capacitors, IC pins, etc.
9. Check whether any key on the keyboard is stuck permanently.
10. Check the address bus, data bus and control bus signals and rule out whether any signal is stuck at 1 or 0.

Systematic Troubleshooting:

Troubleshooting depends on the ability and experience of a hardware engineer. The duration of down time of a computer reflects the capability and performance of a hardware engineer. There are two types of troubleshooting.

- 1. Ad hoc troubleshooting:** It is a type of troubleshooting where an engineer can solve the problem for a short period without doing any proper and systematic diagnosis. In this process though the fault can be eliminated but it may happen again and again. So this type of troubleshooting does not help an engineer always.
- 2. Systematic troubleshooting:** It is the process of troubleshooting in a systematic way. Though it is taking more time as compared to ad hoc troubleshooting, it is reliable and very helpful for a hardware engineer. The systematic troubleshooting can be carried out in the following steps. These steps are:
 - **Symptom's observation:** The first step in troubleshooting of a computer is observing all the symptoms caused by the fault. Any problem of a computer can be diagnosed if the symptoms are studied carefully without missing any point. This technique is highly essential for multiple problems of a computer because due to multiple faults it is impossible to locate exact fault. So, a hardware engineer must have a systematic approach to the problem and starts the troubleshooting with patience and careful observation of the symptoms.
 - **Symptom's analysis:** The second and most important step in troubleshooting is systematic analysis of symptoms of a computer. Careful analysis of symptoms will give clue to the fault location process. For multiple symptoms the engineer should try to correlate various symptoms to identify the exact problem. By analyzing the symptoms properly, a hardware engineer can get the clue and several steps can be skipped during fault location. Hence in this way the performance and ability of a hardware engineer can be improved.
 - **Fault Diagnosis:** Fault diagnosis is highly sophisticated and scientific process. To diagnosis a fault an engineer should have inelegant, presence of mind and detective skill. During diagnosis a fault an engineer should apply multi-dimensional views like:
 - **Architecture:** Before diagnosis an engineer should know the architecture of that computer. So many problems can be detected by analyzing the behavior of the computer including both hardware and software (both system & application software).
 - **Organization:** Two computers having same architecture need not have the same organization. So, before diagnosis a fault the hardware engineer should know the organizational aspect like physical arrangement of various subsystems of that computer. It will help a lot to diagnosis a fault.

- **Engineering Layout:** Certain problems are caused simple by physical layout of faults like faulty cable, loose connection, open wire etc. So to handle these problems an engineer should thoroughly analyze the physical aspects of circuit diagram, board layout diagram, cable signals list, jumper setting etc. of that computer.
- **Environment:** various problems can cause due to environmental condition like high temperature, dust, voltage fluctuations, electrical interference, magnetic field, humidity etc. These problems create very confusing symptoms. So while diagnosis problem environmental effects should be consider.

Fault Rectification:

Fault rectification consists of some simple steps if the problem is diagnosed and the fault is traced properly. The various steps involved in fault rectification are:

1. Replacing a defective IC or other components.
2. Replacing a defective PCB.
3. Cleaning the connectors.
4. Cleaning the R / W head.
5. Soldering a broken wire or connection.
6. Formatting hard disk drive.
7. Isolating electrical loads.
8. Controlling temperature.

If the fault systems still remain even after doing fault rectification as per the diagnosis then there is more than one defective component or the defective component not pointed out exactly. If the problem is not solved than the diagnosis process should be fallowed again.

Logic diagram

It is a flow chart of hardware circuits or program logic. Detailed logic diagrams show all logic functions of the equipment. In addition, they also include such information as socket locations, pin numbers, and test points to help in troubleshooting. The detailed logic diagram for a complete unit may consist of many separate sheets.

Virus concepts

VIRUS stands for “Vital Information Resources Under Siege”. A computer virus is a malicious software program loaded onto a user’s computer without the user’s knowledge and performs malicious actions. The term 'computer virus' was first formally defined by Fred Cohen in 1983. Computer viruses never occur naturally. They are always induced by people.

In more technical terms, a computer virus is a type of malicious code or program written to alter the way a computer operates and is designed to spread from one computer to another. A virus operates by inserting or attaching itself to a legitimate program or document that supports macros in order to execute its code. In the process, a virus has the potential to cause unexpected or damaging effects, such as harming the system software by corrupting or destroying data.

How does a computer virus attack?

Once a virus has successfully attached to a program, file, or document, the virus will lie dormant until circumstances cause the computer or device to execute its code. In order for a virus to infect your computer, you have to run the infected program, which in turn causes the virus code to be executed.

This means that a virus can remain dormant on your computer, without showing major signs or symptoms. However, once the virus infects your computer, the virus can infect other computers on the same network.

How do computer viruses spread?

In a constantly connected world, you can deal a computer virus in many ways. Viruses can be spread through email and text message attachments, Internet file downloads, and social media scam links. Your mobile devices and smartphones can become infected with mobile viruses through shady app downloads. Viruses can hide

disguised as attachments of socially shareable content such as funny images, greeting cards, or audio and video files.

What are the signs of a computer virus?

A computer virus attack can produce a variety of symptoms. Here are some of them:

- **Frequent pop-up windows.** Pop-ups might encourage you to visit unusual sites. Or they might prod you to download antivirus or other software programs.
- **Changes to your homepage.** Your usual homepage may change to another website, for instance. Plus, you may be unable to reset it.
- **Mass emails being sent from your email account.** A criminal may take control of your account or send emails in your name from another infected computer.
- **Frequent crashes.** A virus can inflict major damage on your hard drive. This may cause your device to freeze or crash. It may also prevent your device from coming back on.
- **Unusually slow computer performance.** A sudden change of processing speed could signal that your computer has a virus.
- **Unknown programs that start up when you turn on your computer.** You may become aware of the unfamiliar program when you start your computer. Or you might notice it by checking your computer's list of active applications.
- **Unusual activities like password changes.** This could prevent you from logging into your computer.

What are the different types of computer viruses?

1. **Boot sector virus:** This type of virus can take control when you start — or boot — your computer. One way it can spread is by plugging an infected USB drive into your computer.
2. **Web scripting virus:** This type of virus exploits the code of web browsers and web pages. If you access such a web page, the virus can infect your computer.
3. **Browser hijacker:** This type of virus “hijacks” certain web browser functions, and you may be automatically directed to an unintended website.
4. **Resident virus:** This is a general term for any virus that inserts itself in a computer system's memory. A resident virus can execute anytime when an operating system loads.
5. **Direct action virus:** This type of virus comes into action when you execute a file containing a virus. Otherwise, it remains dormant.
6. **Polymorphic virus:** A polymorphic virus changes its code each time an infected file is executed. It does this to evade antivirus programs.
7. **File infector virus:** This common virus inserts malicious code into executable files — files used to perform certain functions or operations on a system.

8. Multipartite virus: This kind of virus infects and spreads in multiple ways. It can infect both program files and system sectors.
9. Macro virus: Macro viruses are written in the same macro language used for software applications. Such viruses spread when you open an infected document, often through email attachments.

How to remove computer viruses

You can take two approaches to removing a computer virus. One is the manual do-it-yourself approach. The other is by enlisting the help of a reputable antivirus program.

1. Want to do it yourself? There can be a lot of variables when it comes to removing a computer virus. This process usually begins by doing a web search. You may be asked to perform a long list of steps. You'll need time and probably some expertise to complete the process.
2. If you prefer a simpler approach, you can usually remove a computer virus by using an antivirus software program. For instance, Norton Antivirus or Quick Heal or any other Antivirus can remove many infections that are on your computer. These Antivirus products can also help protect you from future threats.

Antivirus

Antivirus software is a vital component of your overall online and computer security strategy in its protection against data and security breaches along with other threats. Antivirus software is a program or set of programs that are designed to prevent, search for, detect, and remove software viruses, and other malicious software like worms, trojans, adware, and more.

What Does Antivirus Software Do?

Antivirus software provides protection against these types of threats by performing key tasks:

- Pinpointing specific files for the detection of malicious software
- Scheduling automatic scans
- Scanning either one file or your entire computer at your discretion
- Deleting malicious codes and software
- Confirming the safety of your computer and other devices

Definition of network: A network is a collection of computers, servers, mainframes, network devices, peripherals, or other devices connected to one another to allow the sharing of data. An example of a network is the Internet, which connects millions of people all over the world. Basically, network is of two types:

1-wire and 2-wireless

Network topologies and

The term network topology describes the relationship of connected devices in terms of a geometric graph. Devices are represented as vertices, and their connections are represented as edges on the graph. It describes how many connections each device has, in what order, and in what sort of hierarchy. Typical network configurations include the bus topology, mesh topology, ring topology, star topology, tree topology and hybrid topology.

Types of networks

Public network: A public network is a network to which anyone can connect. The best example of such a network is the Internet.

Private network: A private network is any network to which access is restricted. A corporate network or a network in a school are examples of private networks.

Types of Computer Network

A LAN (local area network) is a group of computers and network devices connected together, usually within the same building.

A MAN (metropolitan area network) is a larger network that usually spans several buildings in the same city or town.

A WAN (wide area network), in comparison to a MAN, is not restricted to a geographical location, although it might be confined within the bounds of a state or country. A WAN connects several LANs, and may be limited to an enterprise (a corporation or an organization) or accessible to the public. The technology is high speed and relatively expensive. The Internet is an example of a worldwide public WAN.

NIC

Network interface card, the NIC is also referred to as an **Ethernet card** and **network adapter**. A NIC is a computer expansion card for connecting to a network (e.g., home network or Internet) using an Ethernet cable with an RJ-45 connector. Due to the popularity and low cost of the Ethernet standard, nearly all new computers have a network interface built directly into the motherboard.

Network cards can communicate with each other over the same network using a network switch, or if two computers are directly connected. When computers need to connect to a different network (e.g., the Internet), they must use a router to route the network packets to the correct network.

In a desktop computer, the network card is most often located near the USB ports on the back if it is an onboard version. If it is a separate network card (not onboard), it usually is located at the back of the computer, near the bottom, taking up a PCI slot.

In a laptop, the network card is integrated into the motherboard. The network port where you plug in a network cable is often located on the side of the laptop, or it may be located on the back. If you cannot find a network port on your laptop, it may only have a wireless network. You can purchase a network card for laptops, which is installed into a PC card slot on the side of the laptop, if available.

Networking interconnecting devices

HUB

Hub is a kind of device that creates a computer network by connecting multiple computers in a LAN. It has multiple RJ-45 female ports that connect each computer by using twisted pair cable and RJ-45 male connector. The Hub receives data packets from the sender and sends these packets to every other port because it is a Physical layer device. So it has no way to keep track of, which computer is connected to which port. Hub support protocols for ARCNET, Ethernet, FDDI, LocalTalk (Apple), Token Ring and Wireless LAN communication. All incoming lines to a Hub must work at the same speed. Generally, it is used in star topology.

SWITCH

A network switch is an integral part of any local area network and is responsible for providing connectivity between various network segments, along with the control of data traffic within the terminals. A network switch is a device that provides a switching function in a data communications network. Switching involves transferring information, such as digital data packets or frames, among the users of the network.

A switch primarily operates on the layer 2 or data link layer of an OSI model, but it may also operate over layer 3. There are switches which operate over multiple levels and perform all the functions of a router. Modern network switches provide full duplex, uninterrupted communication between all terminals on a local area network. Modern switches operate using the SNMP (Simple Network Management Protocol) that allows for remote monitoring of the data traffic on a network. A switch is keeping the track of the MAC address of attached users to each of its ports and route the signals accordingly to the exact receiving port. Ethernet Network Switches can have bandwidths of 10, 100, 1000 megabits per second.

to control the network traffic with block or access to certain parts of the network through the creation of virtual LANs. Error detection and handling is made simpler with a managed switch due to centralized control and monitoring. This type of switches is used in a very large network where the system administrator needs to control the bandwidth allotment, needs VLAN and monitoring bandwidth usage using SNMP.

ROUTER

Router is a physical device that connects multiple wired or wireless networks together irrespective of different protocols. A router runs software that allows the device to move data from one network to another. Router operates at the network layer of OSI Model i.e. layer-3. Router accepts packets from connected network and passes them to another connected network. If the router is not the member of a network where the receiving node is connected then the router sends the data packet to the next router which is directly connected to it. A router can also allow networks that could not normally communicate with each other to exchange data. In other words a router can connect two different networks. Various routing protocols are used for routing data packets from one network to another network are:-

- Routing Information Protocol (RIP)
- Open Shortest Path First (OSPF)
- Intermediate System to Intermediate System (IS-IS)
- Interior Gateway Routing Protocol (IGRP)
- Enhanced Internal Gateway Routing Protocol (EIGRP)
- Border Gateway Protocol (BGP)

Types of routers

Core router

Core routers are generally used by service providers (i.e. AT&T, Verizon, Vodafone) or cloud providers (i.e. Google, Amazon, Microsoft). They provide maximum bandwidth to connect additional routers or switches. Most small businesses will not need core routers. But very large enterprises that have many employees working in various buildings or locations may use core routers as part of their network architecture.

Edge router

An edge router, also called a gateway router or just "gateway" for short, is a network's outermost point of connection with external networks, including the Internet.

Edge routers are optimized for bandwidth and designed to connect to other routers to distribute data to end users. Edge routers don't usually offer Wi-Fi or the ability to manage local networks fully. They typically have only Ethernet ports—an input to connect to the Internet and several outputs to connect additional routers.

Distribution router

A distribution router, or interior router, receives data from the edge router (or gateway) via a wired connection and sends it on to end users, typically via Wi-Fi, though the router usually also includes physical (Ethernet) connections for connecting users or additional routers.

Wireless router

Wireless routers, or residential gateways, combine the functions of edge routers and distribution routers. These are commonplace routers for home networks and Internet access.

Most service providers provide full-featured wireless routers as standard equipment. But even if you have the option to use an ISP's wireless router in your small business, you may want to use a business-level router to take advantage of better wireless performance, more connectivity controls, and security.

Virtual router

Virtual routers are pieces of software that allow some router functions to be virtualized in the cloud and delivered as a service. These routers are ideal for large businesses with complex network needs. They offer flexibility, easy scalability, and a lower entry cost. Another benefit of virtual routers is reduced management of local network hardware.

Types of Network cable

Network cable acts like a medium through which information travels from one network device to the other. The type of cable selected for a network depends on the network's size, topology, and procedure. The various types of network cables act as the backbone of the network infrastructure. Below are the different types of network cables:

Coaxial Cables

The first type of network cables is the coaxial cables. These network cables were most commonly used for connecting television sets with the antennas.

It is designed in such a way that it transmits high-frequency signals.

Although coaxial cabling is difficult to install, it is highly resistant to signal interference. In addition, it can support greater cable lengths between network devices than twisted pair cable. The two types of coaxial cabling are thick coaxial and thin coaxial.

This cable contains a conductor, insulator, braiding, and sheath. The sheath covers the braiding, braiding covers the insulation, and the insulation covers the conductor.

Sheath: This is the outer layer of the coaxial cable. It protects the cable from physical damage.

Braided shield: This shield protects signals from external interference and noise. This shield is built from the same metal that is used to build the core.

Insulation: Insulation protects the core. It also keeps the core separate from the braided-shield. Since both the core and the braided-shield use the same metal, without this layer, they will touch each other and create a short-circuit in the wire.

Conductor: The conductor carries electromagnetic signals. Based on conductor a coaxial cable can be categorized into two types; single-core coaxial cable and multi-core coaxial cable.