

LEARNING MATERIAL
OF
RENEWABLE ENERGY SOURCES
6TH SEM EE



PREPARED BY:
MR. SAMAR PATASAHANI
ASST.PROF EE

DEPARTMENT OF ELECTRICAL ENGINEERING
C.V RAMAN POLYTECHNIC
BHUBANESWAR

UNIT-I**PRINCIPLES OF SOLAR RADIATION****Role and potential of new and renewable source**

India has a vast supply of renewable energy resources, and it has one of the largest programs in the world for deploying renewable energy products and systems. Indeed, it is the only country in the world to have an exclusive ministry for renewable energy development, the Ministry of Non-Conventional Energy Sources (MNES). Since its formation, the Ministry has launched one of the world's largest and most ambitious programs on renewable energy. Based on various promotional efforts put in place by MNES, significant progress is being made in power generation from renewable energy sources. In October, MNES was renamed the Ministry of New and Renewable Energy.

Specifically, 3,700 MW are currently powered by renewable energy sources (3.5 percent of total installed capacity). This is projected to be 10,000 MW from renewable energy by 2012.

The key drivers for renewable energy are the following:

- o The demand-supply gap, especially as population increases
- o A large untapped potential
- o Concern for the environment
- o The need to strengthen India's energy security
- o Pressure on high-emission industry sectors from their shareholders
- o A viable solution for rural electrification

Also, with a commitment to rural electrification, the Ministry of Power has accelerated the Rural Electrification Program with a target of 100,000 villages by 2012.

Introduction In recent years, India has emerged as one of the leading destinations for investors from developed countries. This attraction is partially due to the lower cost of manpower and good quality production. The expansion of investments has brought benefits of employment, development, and growth in the quality of life, but only to the major cities. This sector only represents a small portion of the total population. The remaining population still lives in very poor conditions.

India is now the eleventh largest economy in the world, fourth in terms of purchasing power. It is poised to make tremendous economic strides over the next ten years, with significant development already in the planning stages. This report gives an overview of the renewable energies market in India. We look at the current status of renewable markets in India, the energy needs of the country, forecasts of consumption and production, and we assess whether India can power its growth and its society with renewable resources.

The Ministry of Power has set an agenda of providing Power to All by 2012. It seeks to achieve this objective through a comprehensive and holistic approach to power sector development envisaging a six level intervention strategy at the National, State, SEB, Distribution, Feeder and Consumer levels.

Environmental impacts of solar energy:

Every energy generation and transmission method affects the environment. As it is obvious conventional generating options can damage air, climate, water, land and wildlife, landscape, as well as raise the levels of harmful radiation. Renewable technologies are substantially safer offering a solution to many environmental and social problems associated with fossil and nuclear fuels (EC,1995,1997). Solar energy technologies (SETs) provide obvious environmental advantages in comparison to the conventional energy sources, thus contributing to the sustainable development of human activities. Not counting the depletion of the exhausted natural resources, their main advantage is related to the reduced CO₂ emissions, and, normally, absence of any air emissions or waste products during their operation. Concerning the environment, the use of SETs has additional positive implications such as:

- * reduction of the emissions of the greenhouse gases (mainly CO₂,NO_x) and prevention of toxic Gas emissions (SO₂,particulates)
- * reclamation of degraded land;
- * reduction of the required transmission lines of the electricity grids; and
- * improvement of the quality of water resources

The basic research in solar energy is being carried in universities and educational and research institutions, public sector institution, BHEL and Central Electronic Limited and carrying out a coordinated program of research of solar energy.

The application of solar energy is

1. Heating and cooling residential buildings
2. Solar water heating
3. Solar drying of agricultural and chemical products.
4. Solar distillation of a small community scale
5. Salt production by evaporation of sea water
6. Solar cookers
7. Solar engines for water pumping
8. Food refrigeration
9. Bio conversion and wind energy and which are indirect source of solar energy
10. Solar furnaces
11. Solar electric power generation by
 - i) Solar ponds
 - ii) Steam generators heated by rotating reflectors
 - iii) reflectors with lenses and pipes for fluid circulation
12. solar photovoltaic cells which can be used for conversion of solar energy directly into electricity (or) for water pumping in rural agriculture purposes.

PRESENT SENERIO:

TPP	-	65.34%
HYDRO	-	21.53%

NUCLEAR	-	2.7%
RENEWABLE	-	10.42%
WIND CAPACITY	-	14550 MW.

20,000 MW solar by 2022.

Installed power generation capacity of India 181.558 GW

Per capita energy consumption stood at 704 KW.

1/3 GW of installed capacity by 2017

Solar Radiation

Solar energy, received in the form of radiation, can be converted directly or indirectly in to other forms of energy, such as heat and electricity. The major draw backs of the extensive application of solar energy of

1. the intermittent and variable manner in which it arrives at the earth's surface and
2. the large area require to collect the energy at a useful rate.

Energy is radiated by the sun as electromagnetic waves of which 99% have wave lengths in the range of 0.2 to 4.0 micro meter (1 micro meter = 10^{-6} meter)

Solar energy reaching the top of the earth's atmosphere consists of about

- 8% ultra violet radiation [short wave length >0.39 micrometer]
- 46% visible light [0.39 to 0.78 micrometer]
- 46 % infrared [0.78 micro meter above]

Solar constant

The sun is a large sphere of very hot gases, the heat being generated by various kinds of fusion reactions. Its diameter is 1.39×10^6 km while that of earth is 1.27×10^4 km. the mean distance between the two is 1.5×10^8 km. although the sun is large, its subtends angle of only 32 min. at the earth's surface.

The brightness of the sun varies from its center to its edge. However the calculation purpose the brightness all over the solar disc is uniform.

The total radiation from the sun is 5762 degrees K

The rate at which solar energy arise at the top of the atmosphere is called the solar constant I_{sc} . This is the amount of energy received in unit time on a unit area perpendicular to the sun's direction at the mean distance of the earth from the sun.

The solar constant value varies up to 3 % throughout the year, because the distance between the sun and the earth varies little throughout the year.

The earth is close set of the sun during the summer and farthest during the winter.

This variation in distance produces sinusoidal variation in the intensity of solar radiation I that reaches the earth.

$$I_{sc} = 1367 \text{ watts/m}^2$$

$$\frac{I}{I_{sc}} = 1 + 0.033 \cos \frac{360 n}{365} \quad \text{where } n \text{ is the day of the year.}$$

Spectral distribution of solar radiation intensity at the outer limit of the atmosphere

The luminosity of the Sun is about 3.86×10^{26} watts. This is the total power radiated out into space by the Sun. Most of this radiation is in the visible and infrared part of the electromagnetic spectrum, with less than 1 % emitted in the radio, UV and X-ray spectral bands. The sun's energy is radiated uniformly in all directions. Because the Sun is about 150 million kilometres from the Earth, and because the Earth is about 6300 km in radius, only 0.000000045% of this power is intercepted by our planet. This still amounts to a massive 1.75×10^{17} watts. For the purposes of solar energy capture, we normally talk about the amount of power in sunlight passing through a single square metre face-on to the sun, at the Earth's distance from the Sun. The power of the sun at the earth, per square metre is called the **solar constant** and is approximately 1370 watts per square metre (W m^{-2}).

The solar constant actually varies by +/- 3% because of the Earth's slightly elliptical orbit around the Sun. The sun-earth distance is smaller when the Earth is at perihelion (first week in January) and larger when the Earth is at aphelion (first week in July). Some people, when talking about the solar constant, correct for this distance variation, and refer to the solar constant as the power per unit area received at the average Earth-solar distance of one "Astronomical Unit" or AU which is 149.59787066 million kilometres. There is also another small variation in the solar constant which is due to a variation in the total luminosity of the Sun itself. This variation has been measured by radiometers aboard several satellites since the late 1970's.

The graph below is a composite graph produced by the World Radiation Centre and shows that our Sun is actually a (slightly) variable star. The variation in the solar constant can be seen to be about 0.1% over a period of 30 years. Some researchers have tried to reconstruct this variation, by correlating it to sunspot numbers, back over the last 400 years, and have suggested that the Sun may have varied in its power output by up to one percent. It has also been suggested that this variation might explain some terrestrial temperature variations. It is interesting to note that the average G-type star (the class of star the Sun falls into) typically shows a much *larger* variation of about 4%.

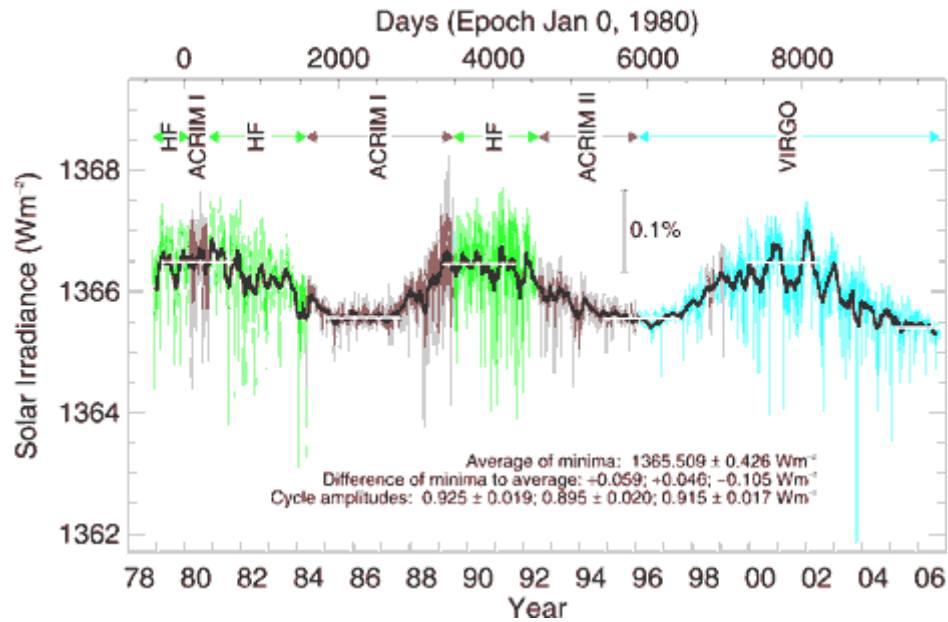

Solar Radiation Measuring Instruments (Radiometers)

A radiometer absorbs solar radiation at its sensor, transforms it into heat and measures the resulting amount of heat to ascertain the level of solar radiation. Methods of measuring heat include taking out heatflux as a temperature change (using a water flow pyr heliometer, a silver-disk pyr heliometer or a bimetallic pyranograph) or as a thermoelectromotive force (using a thermoelectric pyr heliometer or a thermo electric pyranometer). In current operation, types using a thermopile are generally used.

The radiometers used for ordinary observation are pyr heliometers and pyranometers that measure direct solar radiation and global solar radiation, respectively, and these instruments are described in this section. For details of other radiometers such as measuring instruments for diffuse sky radiation and net radiation, refer to "Guide to Meteorological Instruments and Observation Methods" and "Compendium of Lecture Notes on Meteorological Instruments for Training Class III and Class IV Meteorological Personnel" published by WMO.

Pyr heliometers

A pyr heliometer is used to measure direct solar radiation from the sun and its marginal periphery. To measure direct solar radiation correctly, its receiving surface must be arranged to be normal to the solar direction. For this reason, the instrument is usually mounted on a sun-tracking device called an equatorial mount.

The structure of an **Angstrom electrical compensation pyr heliometer** is shown in Figure.

This is a reliable instrument used to observe direct solar radiation, and has long been accepted as a working standard. However, its manual operation requires experience.

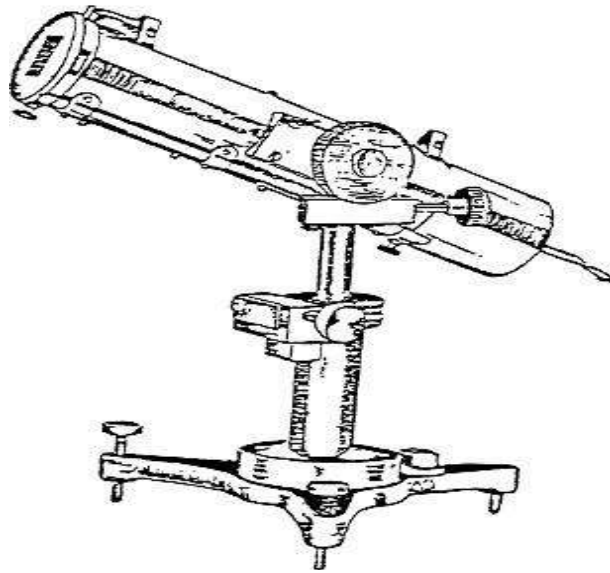

This pyrheliometer has a rectangular aperture, two manganin-strip sensors (20.0 mm × 2.0 mm × 0.02 mm) and several diaphragms to let only direct sunlight reach the sensor. The sensor surface is painted optical black and has uniform absorption characteristics for short-wave radiation. A copper-constantan thermocouple is attached to the rear of each sensor strip, and the thermocouple is connected to a galvanometer. The sensor strips also work as electric resistors and generate heat when a current flows across them.

When solar irradiance is measured with this type of pyrheliometer, the small shutter on the front face of the cylinder shields one sensor strip from sunlight, allowing it to reach only the other sensor. A temperature difference is therefore produced between the two sensor strips because one absorbs solar radiation and the other does not, and a thermoelectromotive force proportional to this difference induces current flow through the galvanometer. Then, a current is supplied to the cooler sensor strip (the one shaded from solar radiation) until the pointer in the galvanometer indicates zero, at which point the temperature raised by solar radiation is compensated by Joule heat. A value for direct solar irradiance is obtained by converting the compensated current at this time. If S is the intensity of direct solar irradiance and i is the current, then $S = Ki^2$,

where K is a constant intrinsic to the instrument and is determined from the size and electric resistance of the sensor strips and the absorption coefficient of their surfaces. The value of K is usually determined through comparison with an upper-class standard pyrheliometer.

Pyranometers:

A pyranometer is used to measure global solar radiation falling on a horizontal surface. Its sensor has a horizontal radiation-sensing surface that absorbs solar radiation energy from the whole sky (i.e. a solid angle of 2π sr) and transforms this energy into heat. Global solar radiation can be ascertained by measuring this heat energy. Most pyranometers in general use are now the thermopile type, although bimetallic pyranometers are occasionally found.

Thermoelectric pyranometer is shown in Figure. The instrument's radiation-sensing element has basically the same structure as that of a thermoelectric pyrhelimeter. Another similarity is that the temperature difference derived between the radiation-sensing element (the hot junction) and the reflecting surface (the cold junction) that serves as a temperature reference point is expressed by a thermopile as anthermoemotive force. In the case of a pyranometer, methods of ascertaining the temperature difference are as follows:

- 1) Several pairs of thermocouples are connected in series to make a thermopile that detects the temperature difference between the black and white radiation-sensing surfaces.
- 2) The temperature difference between two black radiation-sensing surfaces with differing areas is detected by a thermopile.
- 3) The temperature difference between a radiation-sensing surface painted solid black and a metallic block with high heat capacity is detected by a thermopile.

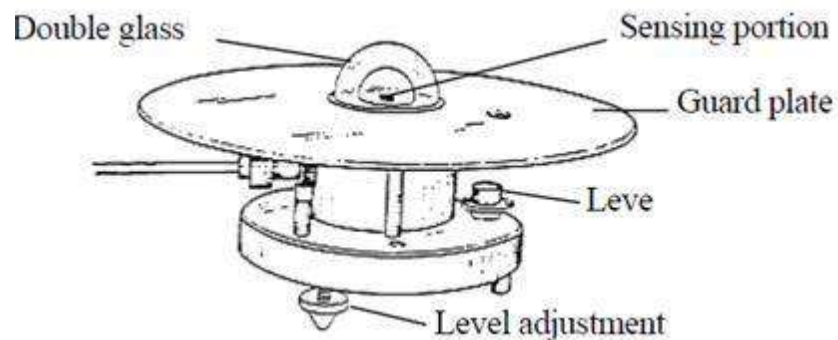

Sunshine recorder

The duration of bright sunshine in a day is measured by means of sun shine recorder. The sun's rays are focused by a glass sphere to a point on a card strip held in a groove in spherical bowl mounted concentrically with the sphere. Whenever there is a bright sun shine the image formed is intensive enough to burn a part on the card strip. through out the day as sun moves across the sky, the image moves along the strip. Thus, a burnt trace whose length is proportional to the duration of sun shine is obtained on the strip.



Solar Radiation Data

Most radiation data is measured for horizontal surfaces. As shown in figure. It is seen a fairly, smooth variations with the maximum occurring around noon is obtained on a clear day. In contrast an irregular variation with many peaks and valleys may be obtained on a cloudy day.

- Peak values are generally measured in April or May with parts of Rajasthan or Gujarat receiving over 600 Langley's per day.
- During the monsoon and winter months, the daily global radiation decreases to about 300- 400 langley per day.
- Annual average daily diffuse radiation received over the whole country is around 175 langleys per day.
- The maximum value is about 300 langleys in Gujarat in July, while the minimum values between 75 and 100 langleys per day, are measured over many parts of the country during November and December as winter sets in.

Solar radiation on tilted surface:

The rate of receipt of solar energy on a given surface on the ground depends on the orientation of the surface with reference to the sun. A fully sun – tracking surface that always faces the sun receives the maximum possible solar energy at the particular location.

A surface of the same area oriented in any other direction will receive a smaller amount of radiation because solar radiation is such a dilute form of energy, it is desirable to capture as much as possible on a ground area. Most of the solar collectors or solar radiation collecting devices are tilted at an angle to horizontal surface with $\gamma=0$ facing south for tilted surface.

$$\cos\theta = \sin\delta \sin(\phi - s) + \cos\delta \cos\omega \cos(\phi - s)$$

For horizontal surfaces $\cos\theta_z = \sin\phi \sin\delta + \cos\phi \cos\delta \cos\omega$

Tilt factor for beam radiation

$$\gamma_b = \frac{\cos\theta}{\cos\theta_z}$$

$$\gamma_d = \left[\frac{1 + \cos s}{2} \right]$$



UNIT II

Solar Energy Collection & Storage and Applications



UNIT-II

SOLAR ENERGY COLLECTION, STORAGE AND APPLICATIONS

Sensible heat storage:

The use of sensible heat energy storage materials is the easiest method of storage. In practice, water, sand, gravel, soil, etc. can be considered as materials for energy storage, in which the largest heat capacity of water, so water is used more often. In the 70's and 80's, the use of water and soil for cross-seasonal storage of solar energy was reported. But the material's sensible heat is low, and it limits energy storage.

Latent heat-storage:

Latent heat-storage units are storing thermal energy in latent (= hidden, dormant) mode by changing the state of aggregation of the storage medium. Applicable storage media are called "phase change materials" (PCM).. Commonly salt crystal is used in low-temperature storage, such as sodium sulfate decahydrate /calcium chloride, sodium hydrogen phosphate 12-water. However, we must solve the cooling and layering issues in order to ensure the operating temperature and service life. Medium solar storage temperature is generally higher than 100 °C but under 500 °C, usually it is around 300 °C. Suitable for medium temperature storage of materials are: high-pressure hot water, organic fluids, eutectic salt. Solar heat storage temperature is generally above 500 °C, the materials currently being tested are: metal sodium and molten salt. Extremely high temperature above 1000 °C storage, fire-resistant ball alumina and germanium oxide can be used.

Chemical, thermal energy storage:

Thermal energy storage is making the use of chemical reaction to store heat. It has the advantage of large amount in heat, small in volume, light in weight. The product of chemical reaction can be stored separately for a long time. It occurs exothermic reaction when it is needed. It has to meet the needs of below conditions to use chemical reaction in heat reserve: good in reaction reversibility, no secondary reaction, rapid reaction, easy to separate the resultant and reserve it stably. Reactant and resultant are innocuous, unflammable, large in heat of reaction and low price of reactant. Now some of the chemical endothermic reaction could meet the needs of above conditions. Like pyrolysis reaction of $\text{Ca}(\text{OH})_2$, Using the above endothermic reaction to store heat and release the heat when it is necessary. But the dehydration reaction temperature in high atmospheric pressure is higher than 500 degrees. It is difficult to use solar energy to complete dehydration reaction. We can use catalyst to decrease the reaction temperature, but still very high. So it is still in testing time of heat reserve in chemistry.

Plastic crystal thermal energy storage:

In 1984, the U.S. market launched plastic crystal materials for home heating. Plastic crystal's scientific name is Neopentyl Glycol (NPG), it and the liquid crystal are similar to three-dimensional periodic crystals, but the mechanical properties are like plastic. It can store and release thermal energy in the constant temperature, but not to rely on solid-liquid phase change to store thermal energy, it stores the energy through the plastic crystalline molecular structure occurring solid - solid phase change. When

plastic crystals are at constant temperature 44c, it absorbs solar energy and stores heat during the day, and releases the heat during the night.

Solar thermal energy storage tank:

Solar pond is a kind of a certain salt concentration gradient of salt ponds, and it can be used for acquisition and storage of solar energy. Because of its simple, low cost, and it is suitable for large-scale application so it has attracted people's attention. After the 60's, many countries have started study on solar pond, Israel has also built three solar pond power plants.

Solar Collectors

Solar collectors are the key component of active solar-heating systems. Solar collectors gather the sun's energy, transform its radiation into heat, then transfer that heat to water, solar fluid, or air. The solar thermal energy can be used in solar water heating systems, solar pool heaters, and solar space-heating systems. There are several types of solar collectors:

- Flat-plate collectors
- Evacuated-tube collectors

Residential and commercial building applications that require temperatures below 200°F typically use flat-plate collectors, whereas those requiring temperatures higher than 200°F use evacuated-tube collectors.

Flat-plate collectors

Flat-plate collectors are the most common solar collector for solar water-heating systems in homes and solar space heating. A typical flat-plate collector is an insulated metal box with a glass or plastic cover (called the glazing) and a dark-colored absorber plate. These collectors heat liquid or air at temperatures less than 180°F. Flat-plate collectors are used for residential water heating and hydronic space-heating installations.

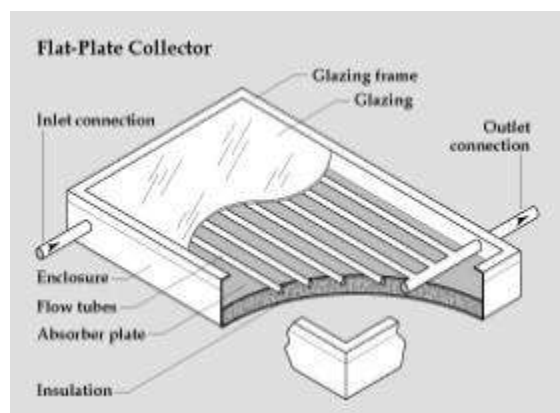

Liquid flat-plate collectors heat liquid as it flows through tubes in or adjacent to the absorber plate. The simplest liquid systems use potable household water, which is heated as it passes directly through the collector and then flows to the house. Solar pool heating This home in Nevada has an integral collector

storage (ICS) system to provide hot water. also uses liquid flat-plate collector technology, but the collectors are typically unglazed as in figure below.

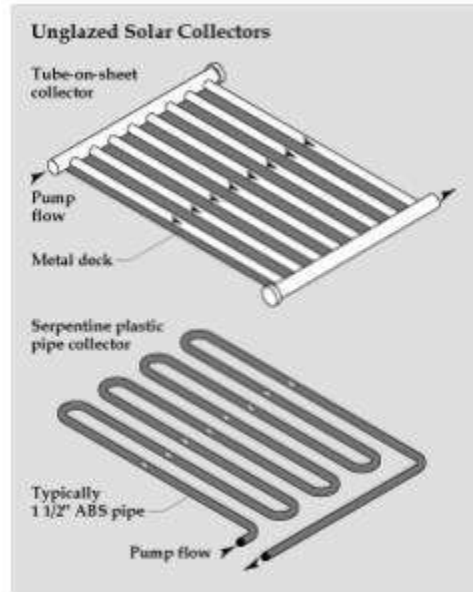

Unglazed solar collectors typically used for swimming pool heating.

Air flat-plate collectors are used primarily for solar space heating. The absorber plates in air collectors can be metal sheets, layers of screen, or non-metallic materials. The air flows past the absorber by using natural convection or a fan. Because air conducts heat much less readily than liquid does, less heat is transferred from an air collector's absorber than from a liquid collector's absorber, and air collectors are typically less efficient than liquid collectors.

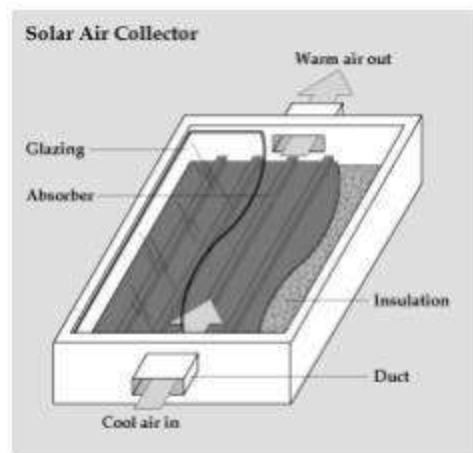

Air flat-plate collectors are used for space heating.

Evacuated-tube collectors

Evacuated-tube collectors can achieve extremely high temperatures (170°F to 350°F), making them more appropriate for cooling applications and commercial and industrial application. However, evacuated-tube collectors are more expensive than flat-plate collectors, with unit area costs about twice

that of flat-plate collectors. Evacuated-tube collectors are efficient at high temperatures. The collectors are usually made of parallel rows of transparent glass tubes. Each tube contains a glass outer tube and metal absorber tube attached to a fin. The fin is covered with a coating that absorbs solar energy well, but which inhibits radiative heat loss. Air is removed, or evacuated, from the space between the two glass tubes to form a vacuum, which eliminates conductive and convective heat loss. A new evacuated-tube design is available from the Chinese manufacturers, such as: Beijing Sunda Solar Energy Technology Co. Ltd. The "dewar" design features a vacuum contained between two concentric glass tubes, with the absorber selective coating on the inside tube. Water is typically allowed to thermosyphon down and back out the inner cavity to transfer the heat to the storage tank. There are no glass-to-metal seals. This type of evacuated tube has the potential to become cost-competitive with flat plates.

Concentrating collectors

Unlike solar (photovoltaic) cells, which use light to produce electricity, concentrating solar power systems generate electricity with heat. Concentrating solar collectors use mirrors and lenses to concentrate and focus sunlight onto a thermal receiver, similar to a boiler tube. The receiver absorbs and converts sunlight into heat. The heat is then transported to a steam generator or engine where it is converted into electricity. There are three main types of concentrating solar power systems: parabolic troughs, dish/engine systems, and central receiver systems.

These technologies can be used to generate electricity for a variety of applications, ranging from remote power systems as small as a few kilowatts (kW) up to grid-connected applications of 200-350 megawatts (MW) or more. A concentrating solar power system that produces 350 MW of electricity displaces the energy equivalent of 2.3 million barrels of oil.

Trough Systems

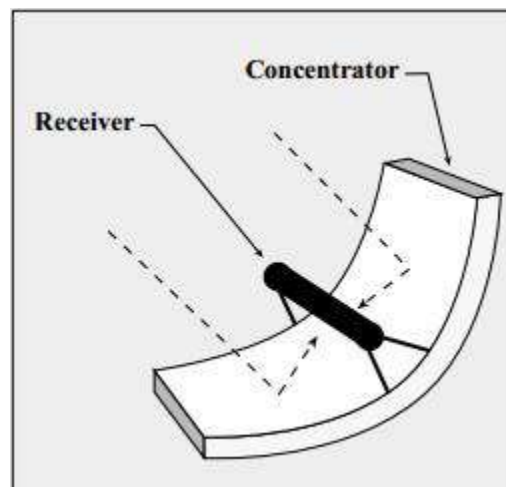

Fig. 1 A parabolic trough

These solar collectors use mirrored parabolic troughs to focus the sun's energy to a fluid-carrying receiver tube located at the focal point of a parabolically curved trough reflector (see Fig.1 above). The energy from the sun sent to the tube heats oil flowing through the tube, and the heat energy is then used to generate electricity in a conventional steam generator. Many troughs placed in parallel rows are called a "collector field." The troughs in the field are all aligned along a north-south axis so they can track the sun from east to west during the day, ensuring that the sun is continuously focused on the receiver pipes. Individual trough systems currently can generate about 80 MW of electricity. Trough

designs can incorporate thermal storage—setting aside the heat transfer fluid in its hot phase—allowing for electricity generation several hours into the evening. Currently, all parabolic trough plants are "hybrids," meaning they use fossil fuels to supplement the solar output during periods of low solar radiation.

Dish Systems

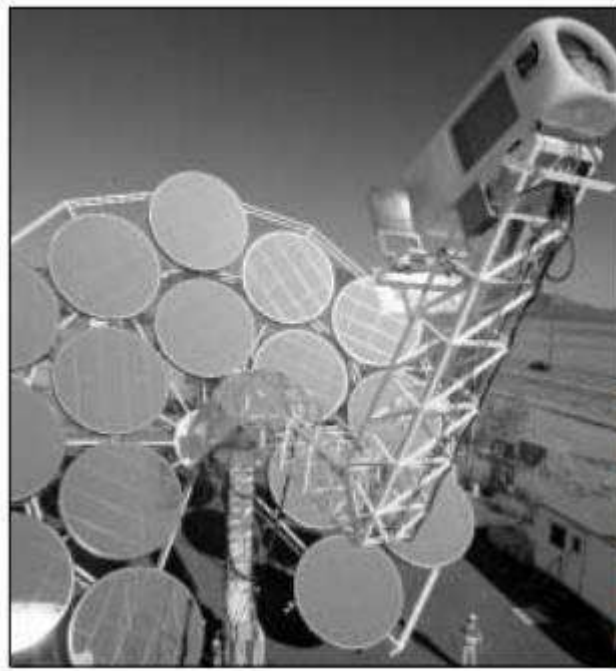

Fig.2 Dish Systems

Dish systems use dish-shaped parabolic mirrors as reflectors to concentrate and focus the sun's rays onto a receiver, which is mounted above the dish at the dish center. A dish/engine system is a standalone unit composed primarily of a collector, a receiver, and an engine (see Fig.2 above). It works by collecting and concentrating the sun's energy with a dish-shaped surface onto a receiver that absorbs the energy and transfers it to the engine. The engine then converts that energy to heat. The heat is then converted to mechanical power, in a manner similar to conventional engines, by compressing the working fluid when it is cold, heating the compressed working fluid, and then expanding it through a turbine or with a piston to produce mechanical power. An electric generator or alternator converts the mechanical power into electrical power.

Dish/engine systems use dual-axis collectors to track the sun. The ideal concentrator shape is parabolic, created either by a single reflective surface or multiple reflectors, or facets. Many options exist for receiver and engine type, including Stirling cycle, microturbine, and concentrating photovoltaic modules. Each dish produces 5 to 50 kW of electricity and can be used independently or linked together to increase generating capacity. A 250-kW plant composed of ten 25-kW dish/engine systems requires less than an acre of land. Dish/engine systems are not commercially available yet, although ongoing demonstrations indicate good potential. Individual dish/engine systems currently can generate about 25 kW of electricity. More capacity is possible by connecting dishes together. These systems can be combined with natural gas, and the resulting hybrid provides continuous power generation.

Central Receiver Systems

Central receivers (or power towers) use thousands of individual sun-tracking mirrors called "heliostats" to reflect solar energy onto a receiver located on top of a tall tower. The receiver collects the sun's heat in a heat-transfer fluid (molten salt) that flows through the receiver. The salt's heat energy is then used to make steam to generate electricity in a conventional steam generator, located at the foot of the tower. The molten salt storage system retains heat efficiently, so it can be stored for hours or even days before being used to generate electricity. Therefore, a central receiver system is composed of five main components: heliostats, receiver, heat transport and exchange, thermal storage, and controls (see Fig. 3). Solar One, Two, "Tres" The U.S. Department of Energy (DOE), and a consortium of U.S. utilities and industry, built this country's first two large-scale, demonstration solar power towers in the desert near Barstow, California. Solar One operated successfully from This concentrating solar power system uses mirrors to focus highly concentrated sunlight onto a receiver that converts the sun's heat into energy. Receiver and generator Concentrator Individual dish/engine systems currently can generate about 25 kW of electricity.

Power tower plants can potentially operate for 65 percent of the year without the need for a back-up fuel source. Solar Two—a demonstration power tower located in the Mojave Desert—can generate about 10 MW of electricity. In this central receiver system, thousands of sun-tracking mirrors called heliostats reflect sunlight onto the receiver. Molten salt at 554°F (290°C) is pumped from a cold storage tank through the receiver where it is heated to about 1,050°F (565°C). The heated salt then moves on to the hot storage tank. When power is needed from the plant, the hot salt is pumped to a generator that produces steam. The steam activates a turbine/generator system that creates electricity. From the steam generator, the salt is returned to the cold storage tank, where it is stored and can be eventually reheated in the receiver. By using thermal storage, power tower plants can potentially operate for 65 percent of the year without the need for a back-up fuel source. Without energy storage, solar technologies like this are limited to annual capacity factors near 25 percent. The power tower's ability to operate for extended periods of time on stored solar energy separates it from other renewable energy technologies. Hot salt storage tank Steam generator 1,050°F Cold salt storage tank Condenser cooling tower 554°F System boundary Substation Steam turbine and electric generator

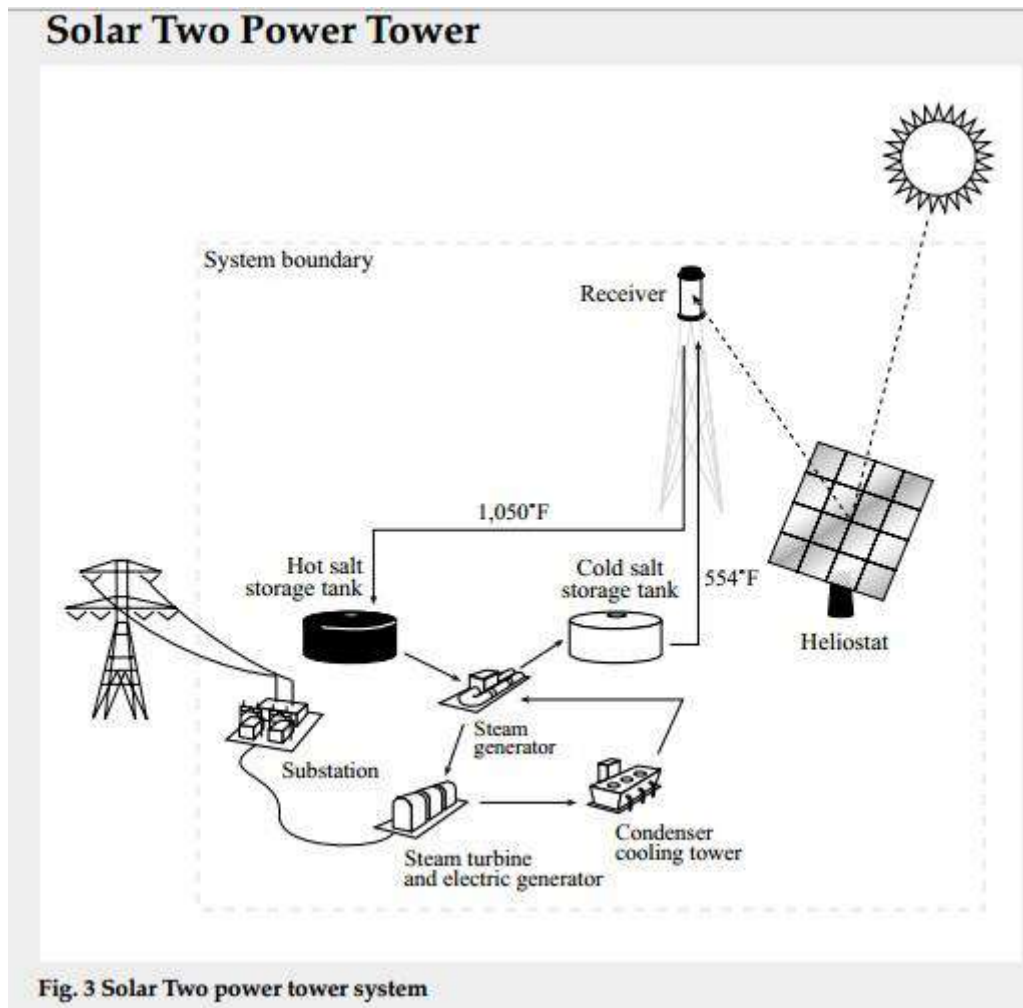

Applications of Solar Energy

Solar energy can supply and or supplement many farm energy requirements. The following is a brief discussion of a few applications of solar energy technologies in agriculture.

Crop And Grain Drying

Using the sun to dry crops and grain is one of the oldest and mostly widely used applications of solar energy. The simplest and least expensive technique is to allow crops to dry naturally in the field, or to spread grain and fruit out in the sun after harvesting. The disadvantage of these methods is that the crops and grains are subject to damage by birds, rodents, wind, and rain, and contamination by wind blown dust and dirt. More sophisticated solar dryers protect grain and fruit, reduce losses, dry faster and more uniformly, and produce a better quality product than open air methods.

The basic components of a solar dryer are an enclosure or shed, screened drying trays or racks, and a solar collector. In hot, arid climates, the collector may not even be necessary. The southern side of the enclosure itself can be glazed to allow sunlight to dry the material. The collector can be as simple as a glazed box with a dark colored interior to absorb the solar energy that heats air. The air heated in the

solar collector moves, either by natural convection or forced by a fan, up through the material being dried. The size of the collector and rate of airflow depends on the amount of material being dried, the moisture content of the material, the humidity in the air, and the average amount of solar radiation available during the drying season.

There is a relatively small number of large solar crop dryers around the world. This is because the cost of the solar collector can be high, and drying rates are not as controllable as they are with natural gas or propane powered dryers. Using the collector at other times of the year, such as for heating farm buildings, may make a solar dryer more cost effective. It is possible to make small, very low cost dryers out of simple materials. These systems can be useful for drying vegetables and fruit for home use.

Space And Water Heating

Livestock and dairy operations often have substantial air and water heating requirements. Modern pig and poultry farms raise animals in enclosed buildings, where it is necessary to carefully control temperature and air quality to maximize the health and growth of the animals. These facilities need to replace the indoor air regularly to remove moisture, toxic gases odors, and dust. Heating this air, when necessary, requires large amount of energy. With proper planning and design solar air/space heaters can be incorporated into farm buildings to preheat incoming fresh air. These systems can also be used to supplement

Solar Energy Applications for Agriculture

Natural ventilation levels during summer months depending on the region and weather. Solar water heating can provide hot water for pen or equipment cleaning or for preheating water going into a conventional water heater. Water heating can account for as much as 25 percent of a typical family's energy costs and up to 40 percent of the energy used in a typical dairy operation. A properly-sized solar water heating system could cut those costs in half.

There are four basic types of solar water-heater systems available. These systems share three similarities: a glazing (typically glass) over a dark surface to gather solar heat; one or two tanks to store hot water; and associated plumbing with or without pumps to circulate the heat-transfer fluid from the tank to the collectors and back again.

(a) Drain down systems pump water from the hot water tank through the solar collector, where it is heated by the sun and returned to the tank. Valves automatically drain the system when sensors detect freezing temperatures.

(b) Drain back systems use a separate plumbing line filled with fluid, to gather the sun's heat. These systems operate strictly on gravity. When the temperature is near freezing, the pump shuts off and the transfer fluid drains back into the solar storage tank.

(c) Anti-freeze closed-loop systems rely on an antifreeze solution to operate through cold and winter months. Anti-freeze solutions are separated from household water by a double-walled heat exchange.

(d) Bread box batch systems are passive systems in which the storage tank also functions as the collector. One or two water tanks, painted black, are placed in a well-insulated box or other enclosure that has a south wall made of clear plastic or glass and tilted at the proper angle. This allows the sun to shine directly on the tank and heat a batch of water. An insulated cover can provide freeze protection.

Greenhouse Heating

Another agricultural application of solar energy is greenhouse heating. Commercial greenhouses typically rely on the sun to supply their lighting needs, but are not designed to use the sun for heating. They rely on gas or oil heaters to maintain the temperatures necessary to grow plants in the colder months. Solar greenhouses, however, are designed to utilize solar energy both for heating and lighting. A solar greenhouse has thermal mass to collect and store solar heat energy, and insulation to retain this heat for use during the night and on cloudy days. A solar greenhouse is oriented to maximize southern glazing exposure. Its northern side has little or no glazing and is well insulated. To reduce heat loss, the glazing itself is also more efficient than single-pane glass, and various products are available ranging from double pane to cellular glazing. A solar greenhouse reduces the need for fossil fuels for heating. A gas or oil heater may serve as a back-up heater, or to increase carbon dioxide levels to induce higher plant growth.

Passive solar greenhouses are often good choices for small growers, because they are a cost-efficient way for farmers to extend the growing season. In colder climates or in areas with long periods of cloudy weather, solar heating may need to be supplemented with a gas or electric heating system to protect plants against extreme cold. Active solar greenhouses use supplemental energy to move solar heated air or water from storage or collection areas to other regions of the greenhouse.

Remote Electricity Supply (Photovoltaic)

Solar electric, or photovoltaic (PV), systems convert sun light directly to electricity. They work any time the sun is shining, but more electricity is produced when the sun light is more intensive and strikes the PV modules directly (as when rays of sunlight are perpendicular to the PV modules). They can also power an electrical appliance directly, or store solar energy in a battery. In areas with no utility lines, PV systems are often cheaper and require less maintenance than diesel generators, wind turbines, or batteries alone. And where utilities charge for new lines, a PV generating system is often much cheaper for the land owner than paying for a new line. PV allows for the production of electricity—without noise or air pollution—from a clean, renewable resource. A PV system never runs out of fuel. Solar electric power comes in very handy on farm and ranches, and is often the most cost-effective and low maintenance solution at locations far from the nearest utility line. PV can be used to power lighting, electric fencing, small motors, aeration fans, gate-openers, irrigation valveswitches, automatic supplement feeders. Solar electric energy can be used to move sprinkler irrigation systems. PV systems are also extremely well-suited for pumping water for livestock in remote pasture, where electricity from power lines is unavailable. PV is often much less-expensive than the alternative of extending power lines into these remote areas.

Water Pumping

Photovoltaic (PV) water pumping systems may be the most cost-effective water pumping option in locations where there is no existing power line. They are exceptionally well suited for grazing operations to supply water to remote pastures. Simple PV power systems run pumps directly when the

sun is shining, so they work hardest in the hot summer months when they are needed most. Generally, batteries are not necessary because the water is stored in tanks or pumped to fields and used in the day time. Larger pumping systems may include batteries, inverters, and tracking mounts to follow the sun. When properly sized and installed, PV water pumps are very reliable and require little maintenance. The size and cost of a PV water pumping system depends on the quality of solar energy available at the site, the pumping depth, the water demand, and system purchase and installation costs. PV systems are very cost-effective for remote livestock water supply, pond aeration, and small irrigation systems. For example, a system that includes a 128 watt PV array and a submersible pump can produce 750-1000 gallons of water per day from 200 foot drilled well.



UNIT III

Wind Energy



UNIT-III WIND ENERGY

History of Wind-Mills:

The wind is a by-product of solar energy. Approximately 2% of the sun's energy reaching the earth is converted into wind energy. The surface of the earth heats and cools unevenly, creating atmospheric pressure zones that make air flow from high- to low pressure areas. The wind has played an important role in the history of human civilization. The first known use of wind dates back 5,000 years to Egypt, where boats used sails to travel from shore to shore. The first true windmill, a machine with vanes attached to an axis to produce circular motion, may have been built as early as 2000 B.C. in ancient Babylon. By the 10th century A.D., windmills with wind-catching surfaces having 16 feet length and 30 feet height were grinding grain in the areas in eastern Iran and Afghanistan. The earliest written references to working wind machines in western world date from the 12th century. These too were used for milling grain. It was not until a few hundred years later that windmills were modified to pump water and reclaim much of Holland from the sea.

The multi-vane "farm windmill" of the American Midwest and West was invented in the United States during the latter half of the 19th century. In 1889 there were 77 windmill factories in the United States, and by the turn of the century, windmills had become a major American export. Until the diesel engine came along, many transcontinental rail routes in the U.S. depended on large multi-vane windmills to pump water for steam locomotives. Farm windmills are still being produced and used, though in reduced numbers. They are best suited for pumping ground water in small quantities to livestock water tanks. In the 1930s and 1940s, hundreds of thousands of electricity producing wind turbines were built in the U.S. They had two or three thin blades which rotated at high speeds to drive electrical generators. These wind turbines provided electricity to farms beyond the reach of power lines and were typically used to charge storage batteries, operate radio receivers and power a light bulb. By the early 1950s, however, the extension of the central power grid to nearly every American household, via the Rural Electrification Administration, eliminated the market for these machines. Wind turbine development lay nearly dormant for the next 20 years.

A typical modern windmill looks as shown in the following figure. The windmill contains three blades about a horizontal axis installed on a tower. A turbine connected to a generator is fixed about the horizontal axis.

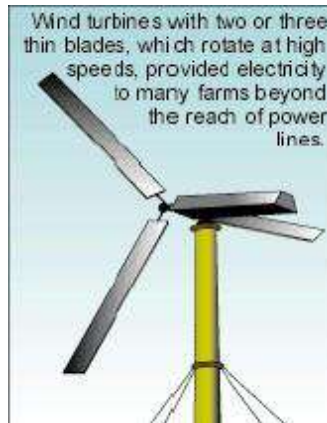

Like the weather in general, the wind can be unpredictable. It varies from place to place, and from moment to moment. Because it is invisible, it is not easily measured without special instruments. Wind velocity is affected by the trees, buildings, hills and valleys around us. Wind is a diffuse energy source that cannot be contained or stored for use elsewhere or at another time.

Classification of Wind-mills:

Wind turbines are classified into two general types: Horizontal axis and Vertical axis. A horizontal axis machine has its blades rotating on an axis parallel to the ground as shown in the above figure. A vertical axis machine has its blades rotating on an axis perpendicular to the ground. There are a number of available designs for both and each type has certain advantages and disadvantages. However, compared with the horizontal axis type, very few vertical axis machines are available commercially.

Horizontal Axis:

This is the most common wind turbine design. In addition to being parallel to the ground, the axis of blade rotation is parallel to the wind flow. Some machines are designed to operate in an upwind mode, with the blades upwind of the tower. In this case, a tail vane is usually used to keep the blades facing into the wind. Other designs operate in a downwind mode so that the wind passes the tower before striking the blades. Without a tail vane, the machine rotor naturally tracks the wind in a downwind mode. Some very large wind turbines use a motor-driven mechanism that turns the machine in response to a wind direction sensor mounted on the tower. Commonly found horizontal axis wind mills are aero-turbine mill with 35% efficiency and farm mills with 15% efficiency.

Vertical Axis:

Although vertical axis wind turbines have existed for centuries, they are not as common as their horizontal counterparts. The main reason for this is that they do not take advantage of the higher wind speeds at higher elevations above the ground as well as horizontal axis turbines. The basic vertical axis designs are the Darrieus, which has curved blades and efficiency of 35%, the Giromill, which has straight blades, and efficiency of 35%, and the Savonius, which uses

scoops to catch the wind and the efficiency of 30%. A vertical axis machine need not be oriented with respect to wind direction. Because the shaft is vertical, the transmission and generator can be mounted at ground level allowing easier servicing and a lighter weight, lower cost tower. Although vertical axis wind turbines have these advantages, their designs are not as efficient at collecting energy from the wind as are the horizontal machine designs. The following figures show all the above mentioned mills.

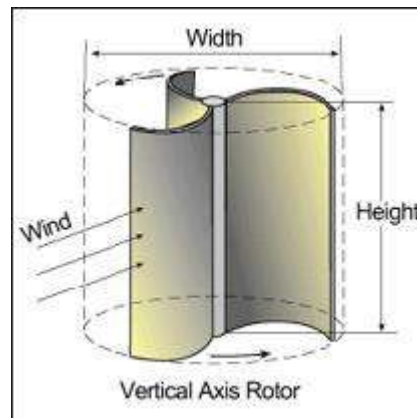
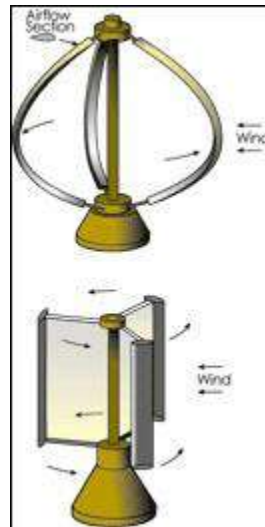

There is one more type of wind-mill called Cyclo-gyro wind-mill with very high efficiency of about 60%. However, it is not very stable and is very sensitive to wind direction. It is also very complex to build.

Main Components of a wind-mill :

Following figure shows typical components of a horizontal axis wind mill.

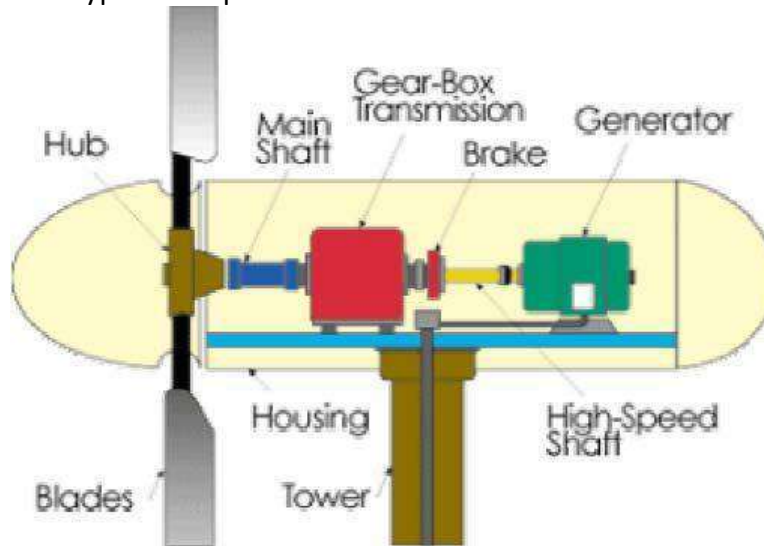

Rotor:

The portion of the wind turbine that collects energy from the wind is called the rotor. The rotor usually consists of two or more wooden, fiberglass or metal blades which rotate about an axis (horizontal or vertical) at a rate determined by the wind speed and the shape of the blades. The blades are attached to the hub, which in turn is attached to the main shaft.

Drag Design:

Blade designs operate on either the principle of drag or lift. For the drag design, the wind literally pushes the blades out of the way. Drag powered wind turbines are characterized by slower rotational speeds and high torque capabilities. They are useful for the pumping, sawing or grinding work. For example, a farm-type windmill must develop high torque at start-up in order to pump, or lift, water from a deep well.

Lift Design:

The lift blade design employs the same principle that enables airplanes, kites and birds to fly. The blade is essentially an airfoil, or wing. When air flows past the blade, a wind speed and pressure differential is created between the upper and lower blade surfaces. The pressure at the lower surface is greater and thus acts to "lift" the blade. When blades are attached to a central axis, like a wind turbine rotor, the lift is translated into rotational motion. Lift-powered wind turbines have much higher rotational speeds than drag types and therefore well suited for electricity generation.

Tip Speed Ratio:

The tip-speed is the ratio of the rotational speed of the blade to the wind speed. The larger this ratio, the faster the rotation of the wind turbine rotor at a given wind speed. Electricity generation requires high rotational speeds. Lift-type wind turbines have maximum tip-speed ratios of around 10, while drag-type ratios are approximately 1. Given the high rotational speed requirements of electrical generators, it is clear that the lift-type wind turbine is most practical for this application.

The number of blades that make up a rotor and the total area they cover affect wind turbine performance. For a lift-type rotor to function effectively, the wind must flow smoothly over the blades. To avoid turbulence, spacing between blades should be great enough so that one blade will not encounter the disturbed, weaker air flow caused by the blade which passed before it. It is because of this requirement that most wind turbines have only two or three blades on their rotors.

Generator:

The generator is what converts the turning motion of a wind turbine's blades into electricity. Inside this component, coils of wire are rotated in a magnetic field to produce electricity. Different generator designs produce either alternating current (AC) or direct current (DC), and they are available in a large range of output power ratings. The generator's rating, or size, is dependent on the length of the wind turbine's blades because more energy is captured by longer blades.

It is important to select the right type of generator to match intended use. Most home and office appliances operate on 240 volt, 50 cycles AC. Some appliances can operate on either AC or DC, such as light bulbs and resistance heaters, and many others can be adapted to run on DC. Storage systems using batteries store DC and usually are configured at voltages of between 12 volts and 120 volts.

Generators that produce AC are generally equipped with features to produce the correct voltage of 240 V and constant frequency 50 cycles of electricity, even when the wind speed is fluctuating.

DC generators are normally used in battery charging applications and for operating DC appliances and machinery. They also can be used to produce AC electricity with the use of an inverter, which converts DC to AC.

Transmission:

The number of revolutions per minute (rpm) of a wind turbine rotor can range between 40 rpm and 400 rpm, depending on the model and the wind speed. Generators typically require rpm's of 1,200 to 1,800. As a result, most wind turbines require a gear-box transmission to increase the rotation of the generator to the speeds necessary for efficient electricity production. Some DC-type wind turbines do not use transmissions. Instead, they have a direct link between the rotor and generator. These are known as direct drive systems. Without a transmission, wind turbine complexity and maintenance requirements are reduced, but a much larger generator is required to deliver the same power output as the AC-type wind turbines.

Tower:

The tower on which a wind turbine is mounted is not just a support structure. It also raises the wind turbine so that its blades safely clear the ground and so it can reach the stronger winds at higher elevations. Maximum tower height is optional in most cases, except where zoning restrictions apply. The decision of what height tower to use will be based on the cost of taller towers versus the value of the increase in energy production resulting from their use. Studies have shown that the added cost of increasing tower height is often justified by the added power generated from the stronger winds. Larger wind turbines are usually mounted on towers ranging from 40 to 70 meters tall.

Towers for small wind systems are generally "guyed" designs. This means that there are guy wires anchored to the ground on three or four sides of the tower to hold it erect. These towers cost less than freestanding towers, but require more land area to anchor the guy wires. Some of these guyed towers are erected by tilting them up. This operation can be quickly accomplished using only a winch, with the turbine already mounted to the tower top. This simplifies not only installation, but maintenance as well. Towers can be constructed of a simple tube, a wooden pole or a lattice of tubes, rods, and angle iron. Large wind turbines may be mounted on lattice towers, tube towers or guyed tilt-up towers.

Towers must be strong enough to support the wind turbine and to sustain vibration, wind loading and the overall weather elements for the lifetime of the wind turbine. Their costs will vary widely as a function of design and height.

Operating Characteristics of wind mills:

All wind machines share certain operating characteristics, such as cut-in, rated and cutout wind speeds.

Cut-in Speed:

Cut-in speed is the minimum wind speed at which the blades will turn and generate usable power. This wind speed is typically between 10 and 16 kmph.

Rated Speed:

The rated speed is the minimum wind speed at which the wind turbine will generate its designated rated power. For example, a "10 kilowatt" wind turbine may not generate 10 kilowatts until wind speeds reach 40 kmph. Rated speed for most machines is in the range of 40 to 55 kmph. At wind speeds between cut-in and rated, the power output from a wind turbine increases as the wind increases. The output of most machines levels off above the rated speed. Most manufacturers provide graphs, called "power curves," showing how their wind turbine output varies with wind speed.

Cut-out Speed:

At very high wind speeds, typically between 72 and 128 kmph, most wind turbines cease power generation and shut down. The wind speed at which shut down occurs is called the cut-out speed. Having a cut-out speed is a safety feature which protects the wind turbine from damage. Shut down may occur in one of several ways. In some machines an automatic brake is activated by a wind speed sensor. Some machines twist or "pitch" the blades to spill the wind. Still others use "spoilers," drag flaps mounted on the blades or the hub which are automatically activated by high rotor rpm's, or mechanically activated by a spring loaded device which turns the machine sideways to the wind stream. Normal wind turbine operation usually resumes when the wind drops back to a safe level.

Betz Limit:

It is the flow of air over the blades and through the rotor area that makes a wind turbine function. The wind turbine extracts energy by slowing the wind down. The theoretical maximum amount of energy in the wind that can be collected by a wind turbine's rotor is approximately 59%. This value is known as the Betz limit. If the blades were 100% efficient, a wind turbine would not work because the air, having given up all its energy, would entirely stop. In practice, the collection efficiency of a rotor is not as high as 59%. A more typical efficiency is 35% to 45%. A complete wind energy system, including rotor, transmission, generator, storage and other devices, which all have less than perfect efficiencies, will deliver between 10% and 30% of the original energy available in the wind.

The following plot gives the relationship between wind speed in KMPH and the power density.

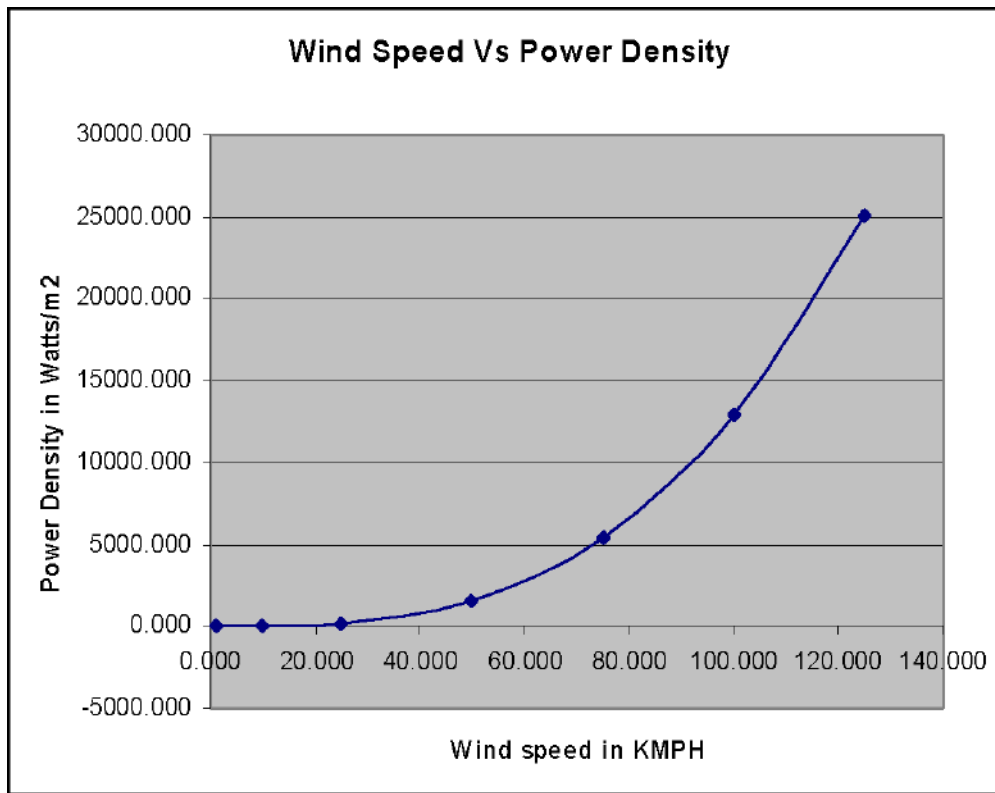

In the last column of the table, we have calculated the output of the turbine assuming that the efficiency of the turbine is 30%. However, we need to remember that the efficiency of the turbine is a function of wind speed. *It varies with wind speed.*

Now, let us try to calculate the wind speed required to generate power equivalent to 1 square meter PV panel with 12% efficiency. We know that solar insolation available at the PV panel is 1000 watts/m² at standard condition. Hence the output of the PV panel with 12% efficiency would be 120 watts. Now the speed required to generate this power by the turbine with 30% efficiency can be calculated as follows:

Turbine output required = 120 Watts/m²

Power Density at the blades = $120 / (0.3) = 400 \text{ watts/m}^2$

BIOMASS:**Introduction:**

Biomass is the term used to describe all the organic matter, produced by photosynthesis that exists on the earth's surface. The source of all energy in biomass is the sun, the biomass acting as a kind of chemical energy store. Biomass is constantly undergoing a complex series of physical and chemical transformations and being regenerated while giving off energy in the form of heat to the atmosphere. To make use of biomass for our own energy needs we can simply tap into this energy source, in its simplest form we know, this is a basic open fire used to provide heat for cooking, warming water or warming the air in our home. More sophisticated technologies exist for extracting this energy and converting it into useful heat or power in an efficient way.

The exploitation of energy from biomass has played a key role in the evolution of mankind. Until relatively recently it was the only form of energy which was usefully exploited by humans and is still the main source of energy for more than half the world's population for domestic energy needs. Traditionally the extraction of energy from biomass is split into 3 distinct categories:

Solid biomass - the use of trees, crop residues, animal and human waste (all though not strictly a solid biomass source, it is often included in this category for the sake of convenience), household or industrial residues for direct combustion to provide heat. Often the solid biomass will undergo physical processing such as cutting, chipping, briquetting, etc. but retains its solid form.

Biogas - biogas is obtained by anaerobically (in an air free environment) digesting organic material to produce a combustible gas known as methane. Animal waste and municipal waste are two common feed stocks for anaerobic digestion.

Liquid Biofuels - are obtained by subjecting organic materials to one of various chemical or physical processes to produce a usable, combustible, liquid fuel. Biofuels such as vegetable oils or ethanol are often processed from industrial or commercial residues such as bagasse (sugarcane residue remaining after the sugar is extracted) or from energy crops grown specifically for **Micro-organisms**, like all living things, **require food for growth**. Biological sewage treatment consists of a step-by-step, continuous, sequenced attack on the organic compounds found in wastewater and upon which the microbes feed.

Aerobic Digestion

Aerobic digestion of waste is the natural biological degradation and purification process in which bacteria that thrive in oxygen-rich environments break down and digest the waste.

During oxidation process, pollutants are broken down into carbon dioxide (CO_2), water (H_2O), nitrates, sulphates and biomass (microorganisms). By operating the oxygen supply with **aerators**, the process can be significantly accelerated. Of all the biological treatment methods, aerobic digestion is the most widespread process that is used throughout the world.

Biological and chemical oxygen demand

Aerobic bacteria demand oxygen to decompose dissolved pollutants. Large amounts of pollutants require large quantities of bacteria; therefore the demand for oxygen will be high.

The Biological Oxygen Demand (BOD) is a measure of the quantity of dissolved organic pollutants that can be removed in biological oxidation by the bacteria. It is expressed in **mg/l**.

The Chemical Oxygen Demand (COD) measures the quantity of dissolved organic pollutants than can be removed in chemical oxidation, by adding strong acids. It is expressed in **mg/l**.

The **BOD/COD** gives an indication of the fraction of pollutants in the wastewater that is biodegradable.

Advantages of Aerobic Digestion

Aerobic bacteria are very efficient in breaking down waste products. The result of this is; aerobic treatment usually yields better effluent quality that that obtained in anaerobic processes. The aerobic pathway also releases a substantial amount of energy. A portion is used by the microorganisms for synthesis and growth of new microorganisms.

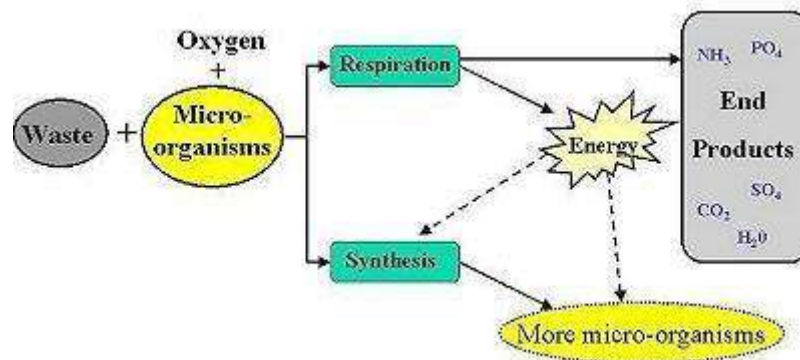

Path of Aerobic Digestion

Aerobic Decomposition

A biological process, in which, organisms use available organic matter to support biological activity. The process uses organic matter, nutrients, and dissolved oxygen, and produces stable solids, carbondioxide, and more organisms. The microorganisms which can only survive in aerobic conditions are known as aerobic organisms. In sewer lines the sewage becomes anoxic if left for a few hours and becomes anaerobic if left for more than 1 1/2 days. Anoxic organisms work well with aerobic and anaerobic organisms. Facultative and anoxic are basically the same concept.

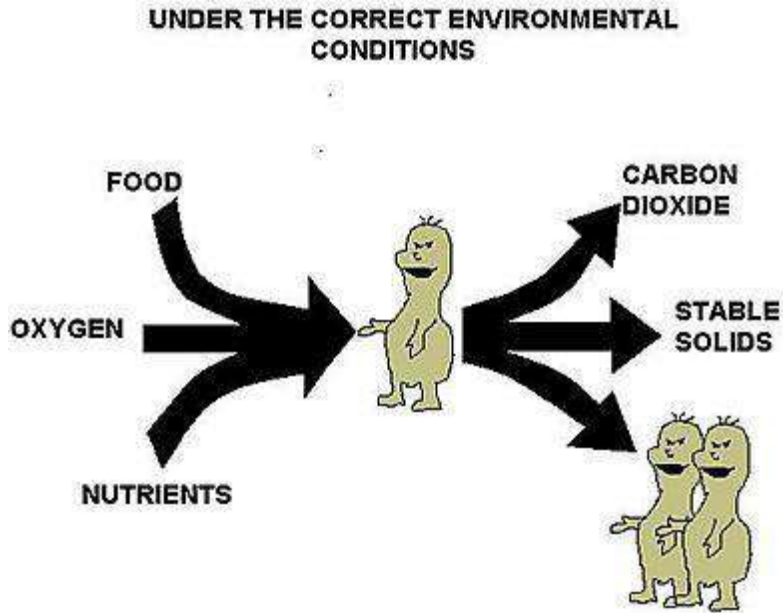

Anoxic Decomposition

A biological process in which a certain group of microorganisms use chemically combined oxygen such as that found in nitrite and nitrate. These organisms consume organic matter to support life functions. They use organic matter, combined oxygen from nitrate, and nutrients to produce nitrogen gas, carbon dioxide, stable solids and more organisms.

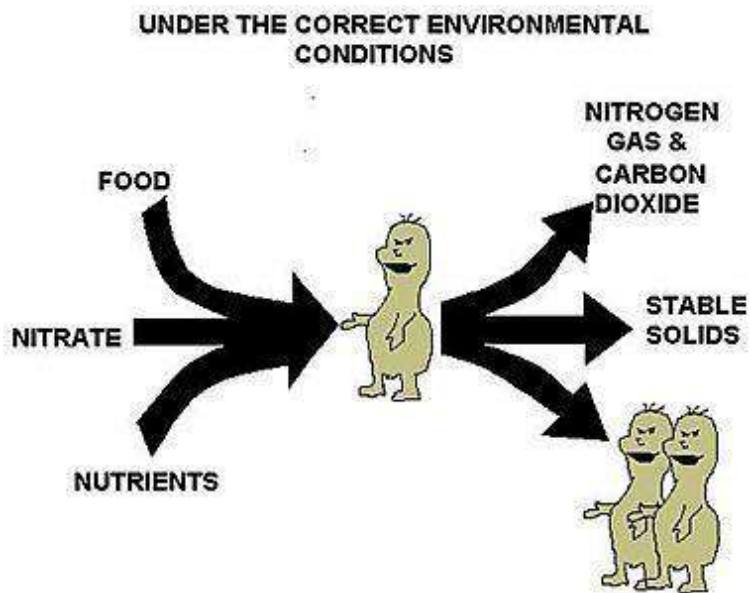

Anaerobic Digestion

Anaerobic digestion is a complex biochemical reaction carried out in a number of steps by several types of microorganisms that require little or no oxygen to live. During this process, a gas that is mainly composed of methane and carbon dioxide, also referred to as biogas, is produced. The amount of gas produced varies with the amount of organic waste fed to the digester and temperature influences the rate of decomposition and gas production.

Anaerobic digestion occurs in four steps:

- **Hydrolysis** : Complex organic matter is decomposed into simple soluble organic molecules using water to split the chemical bonds between the substances.
- **Fermentation or Acidogenesis**: The chemical decomposition of carbohydrates by enzymes, bacteria, yeasts, or molds in the absence of oxygen.
- **Acetogenesis**: The fermentation products are converted into acetate, hydrogen and carbon dioxide by what are known as acetogenic bacteria.
- **Methanogenesis**: Is formed from acetate and hydrogen/carbon dioxide by methanogenic bacteria.

The acetogenic bacteria grow in close association with the methanogenic bacteria during the fourth stage of the process. The reason for this is that the conversion of the fermentation products by the acetogens is thermodynamically only if the hydrogen concentration is kept sufficiently low. This requires a close relationship between both classes of bacteria.

The anaerobic process only takes place under strict anaerobic conditions. It requires specific adapted bio-solids and particular process conditions, which are considerably different from those needed for aerobic treatment.

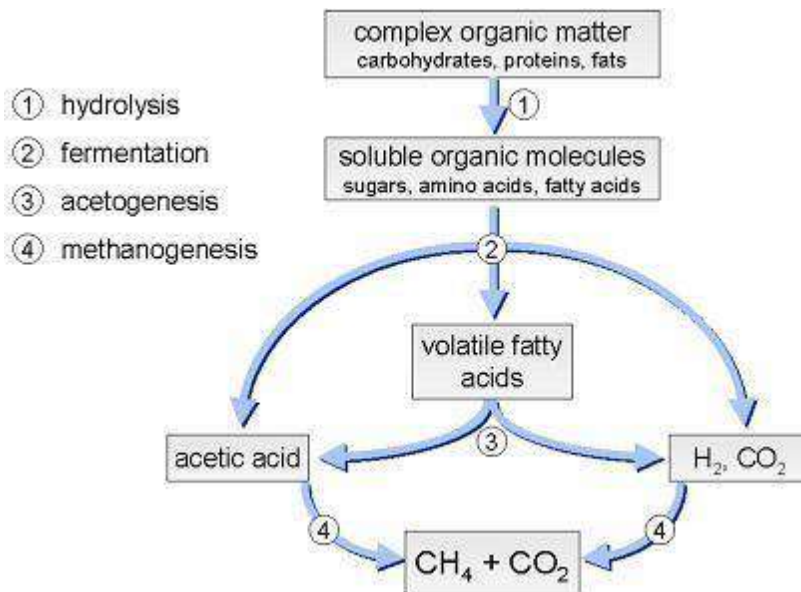

Path of Anaerobic Digestion

Advantages of Anaerobic Digestion

Wastewater pollutants are transformed into methane, carbon dioxide and smaller amount of bio-solids. The biomass growth is much lower compared to those in the aerobic processes. They are also much more compact than the aerobic bio-solids.

Anaerobic Decomposition

A biological process, in which, decomposition of organic matter occurs without oxygen. Two processes occur during anaerobic decomposition. First, facultative acid forming bacteria use organic matter as a food source and produce volatile (organic) acids, gases such as carbon dioxide and hydrogen sulfide, stable solids and more facultative organisms. Second, anaerobic methane formers use the volatile acids as a food source and produce methane gas, stable solids and more anaerobic methane formers. The methane gas produced by the process is usable as a fuel. The methane former works slower than the acid former, therefore the pH has to stay constant consistently, slightly basic, to optimize the creation of methane. You need to constantly feed it sodium bicarbonate to keep it basic.

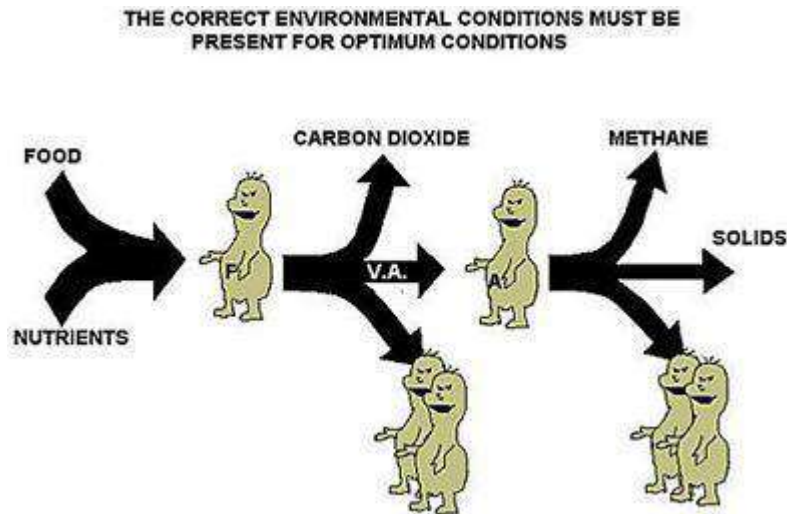

Biogas - Digester types

In this chapter, the most important types of biogas plants are described:

- Fixed-dome plants
- Floating-drum plants
- Balloon plants
- Horizontal plants
- Earth-pit plants
- Ferrocement plants

Of these, the two most familiar types in developing countries are the **fixed-dome plants** and the **floating-drum** plants. Typical designs in industrialized countries and appropriate design selection criteria have also been considered.

Fixed-dome plants

The costs of a fixed-dome biogas plant are relatively low. It is simple as no moving parts exist. There are also no rusting steel parts and hence a long life of the plant (20 years or more) can be expected. The plant is constructed underground, protecting it from physical damage and saving space. While the underground digester is protected from low temperatures at night and during cold seasons, sunshine and warm seasons take longer to heat up the digester. No day/night fluctuations of temperature in the digester positively influence the bacteriological processes.

The construction of fixed dome plants is labor-intensive, thus creating local employment. Fixed-dome plants are not easy to build. They should only be built where construction can be supervised by experienced biogas technicians. Otherwise plants may not be gas-tight (porosity and cracks). The basic elements of a fixed dome plant (here the **Nicarao Design**) are shown in the figure below.

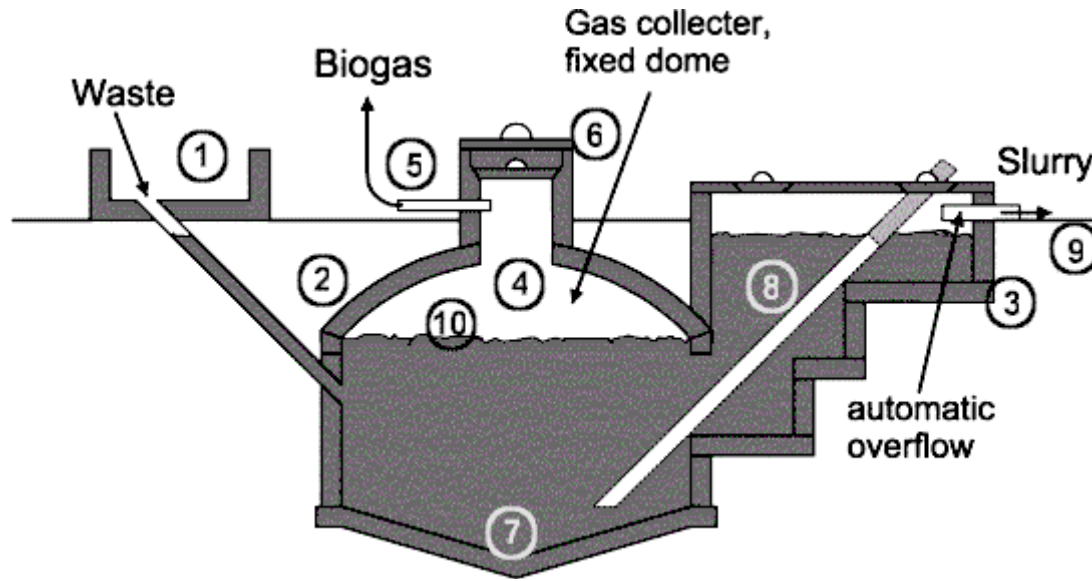

Figure 1: Fixed dome plant Nicarao design: 1. Mixing tank with inlet pipe and sand trap. 2. Digester. 3. Compensation and removal tank. 4. Gasholder. 5. Gaspipe. 6. Entry hatch, with gastight seal. 7. Accumulation of thick sludge. 8. Outlet pipe. 9. Reference level. 10. Supernatant scum, broken up by varying level.

Function

A fixed-dome plant comprises of a closed, dome-shaped digester with an immovable, rigid gas-holder and a displacement pit, also named 'compensation tank'. The gas is stored in the upper part of the digester. When gas production commences, the slurry is displaced into the compensating tank. Gas pressure increases with the volume of gas stored, i.e. with the height difference between the two slurry levels. If there is little gas in the gasholder, the gas pressure is low.

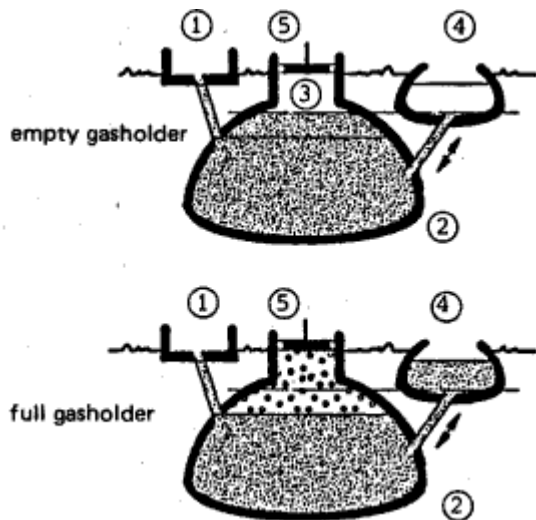

Figure 2: Basic function of a fixed-dome biogas plant, 1 Mixing pit, 2 Digester, 3 Gasholder, 4 Displacement pit, 5 Gas pipe

Digester:

The digesters of fixed-dome plants are usually masonry structures, structures of cement and ferro-cement exist. Main parameters for the choice of material are:

- . Technical suitability (stability, gas- and liquid tightness);
- . cost-effectiveness;
- . availability in the region and transport costs;
- . availability of local skills for working with the particular building material.

Fixed dome plants produce just as much gas as floating-drum plants, if they are gas-tight. However, utilization of the gas is less effective as the gas pressure fluctuates substantially. Burners and other simple appliances cannot be set in an optimal way. If the gas is required at constant pressure (e.g., for engines), a gas pressure regulator or a floating gas-holder is necessary.

Gas-Holder:

Figure 3: Fixed-dome plant in Tunisia. The final layers of the masonry structure are being fixed.

The top part of a fixed-dome plant (the gas space) must be gas-tight. Concrete, masonry and cement rendering are not gas-tight. The gas space must therefore be painted with a gas-tight layer (e.g. 'Water-proofer', Latex or synthetic paints). A possibility to reduce the risk of cracking of the gas-holder consists in the construction of a weak-ring in the masonry of the digester. This "ring" is a flexible joint between the lower (water-proof) and the upper(gas-proof) part of the hemispherical structure. It prevents cracks that develop due to the hydrostatic pressure in the lower parts to move into the upper parts of the gas-holder.

Types of fixed-dome plants

- . **Chinese fixed-dome plant** is the archetype of all fixed dome plants. Several million have been constructed in China. The digester consists of a cylinder with round bottom and top.
- . **Janata model** was the first fixed-dome design in India, as a response to the Chinese fixed dome plant. It is not constructed anymore. The mode of construction lead to cracks in the gasholder - very few of these plant had been gas-tight.
- . **Deenbandhu** the successor of the Janata plant in India, with improved design, was more crack-proof and consumed less building material than the Janata plant. with a hemisphere digester

· **CAMARTEC model** has a simplified structure of a hemispherical dome shell based on a rigid foundation ring only and a calculated joint of fraction, the so-called weak / strong ring. It was developed in the late 80s in Tanzania.

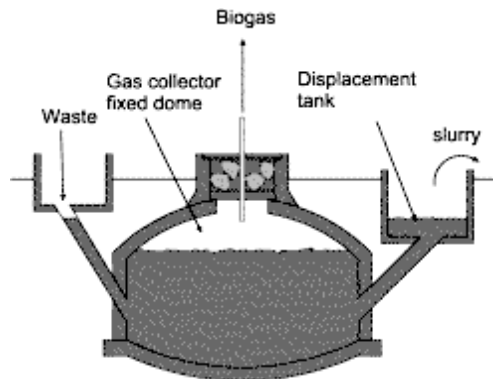

Figure 4: Chinese fixed dome plant

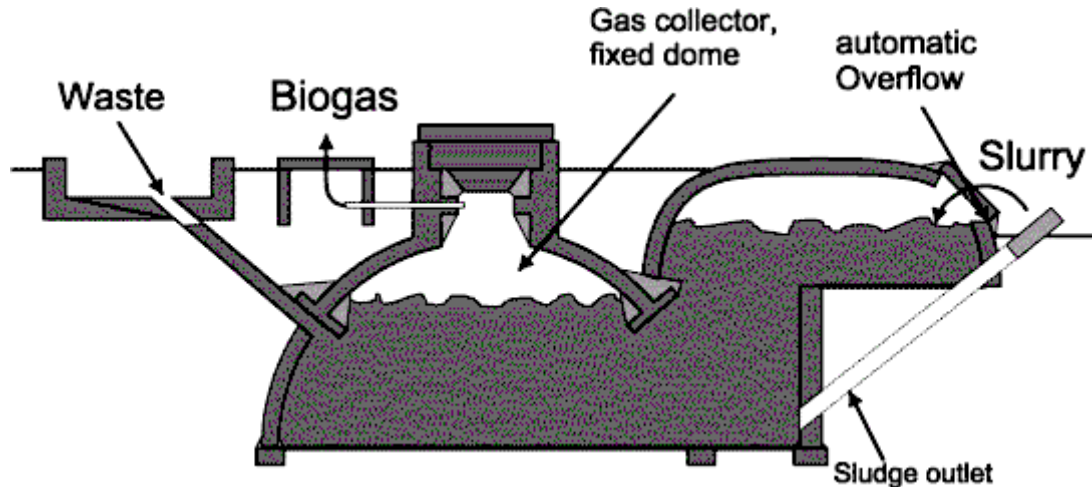

Figure 5: Fixed dome plant CAMARTEC design

Climate and size

Fixed-dome plants must be covered with earth up to the top of the gas-filled space to counteract the internal pressure (up to 0,15 bar). The earth cover insulation and the option for internal heating makes them suitable for colder climates. Due to economic parameters, the recommended minimum size of a fixed-dome plant is 5 m³. Digester volumes up to 200m³ are known and possible.

Advantages: Low initial costs and long useful life-span; no moving or rusting parts involved; basic design is compact, saves space and is well insulated; construction creates local employment.

Disadvantages: Masonry gas-holders require special sealants and high technical skills for gas-tight construction; gas leaks occur quite frequently; fluctuating gas pressure complicates gas utilization; amount of gas produced is not immediately visible, plant operation not readily understandable; fixed dome plants need exact planning of levels; excavation can be difficult and expensive in bedrock.

Fixed dome plants can be recommended only where construction can be supervised by experienced biogas technicians.



Figure 6: Installation of a Shanghai fixed-dome system near Shanghai, PR China Floating-drum plants

Floating – drum plants

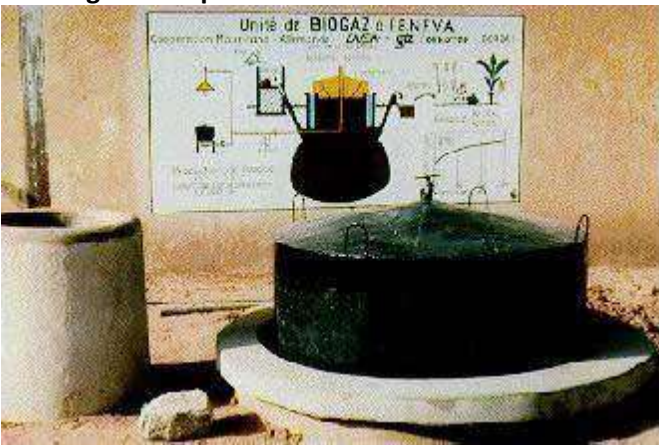

Figure 7: Floating-drum plant in Mauretania

The drum

In the past, floating-drum plants were mainly built in India. A floating-drum plant consists of a cylindrical or dome shaped digester and a moving, floating gas-holder, or drum. The gas-holder floats either directly in the fermenting slurry or in a separate water jacket. The drum in which the biogas collects has an internal and/or external guide frame that provides stability and keeps the drum upright. If biogas is produced, the drum moves up, if gas is consumed, the gas holder sinks back.

Size

Floating-drum plants are used chiefly for digesting animal and human feces on a continuous feed mode of operation, i.e. with daily input. They are used most frequently by small- to middle-sized farms (digester size: 5-15m³) or in institutions and larger agro-industrial estates (digester size: 20-100m³).

Advantages: Floating-drum plants are easy to understand and operate. They provide gas at a constant pressure, and the stored gas-volume is immediately recognizable by the position of the drum. Gas-tightness is no problem, provided the gasholder is de-rusted and painted regularly.

Disadvantages: The steel drum is relatively expensive and maintenance-intensive. Removing rust and painting has to be carried out regularly. The life-time of the drum is short (up to 15 years; in tropical coastal regions about five years). If fibrous substrates are used, the gas-holder shows a tendency to get "stuck" in the resultant floating scum.

Types of floating-drum plants

There are different types of floating-drum plants (see drawings under Construction):

- **KVIC model** with a cylindrical digester, the oldest and most widespread floating drum biogas plant from India.
- **Pragati model** with a hemisphere digester
- **Ganesh model** made of angular steel and plastic foil floating-drum plant made of pre-fabricated reinforced concrete compound units floating-drum plant made of fibre-glass reinforced polyester
- **BORDA model**: The BORDA-plant combines the static advantages of hemispherical digester with the process-stability of the floating-drum and the longer life span of a water jacket plant.



UNIT IV

Geothermal Energy & Tidal and Wave Energy



UNIT-IV

GEOTHERMAL ENERGY

Introduction

The word geothermal comes from the Greek words *geo* (Earth) and *therme*(heat). Geothermal energy is heat from within the Earth. Geothermal energy is generated in the Earth's **core**, almost 4,000miles beneath the Earth's surface. The double-layered core is made up of very hot **magma** (melted rock) surrounding a solid iron center. Very high temperatures are continuously produced inside the Earth by the slow decay of radioactive particles. This process is natural in all rocks.

Surrounding the outer core is the **mantle**, which is about 1,800 miles thick and made of magma and rock. The outermost layer of the Earth, the land that forms the continents and ocean floors, is called the **crust**. The crust is three to five miles thick under the oceans and 15 to 35 miles thick on the continents. The crust is not a solid piece, like the shell of an egg, but is broken into pieces called **plates**. Magma comes close to the Earth's surface near the edges of these plates. This is where volcanoes occur. The lava that erupts from volcanoes is partly magma. Deep underground, the rocks and water absorb the heat from this magma. We can dig wells and pump the heated, underground water to the surface. People around the world use geothermal energy to heat their homes and to produce electricity. Geothermal energy is called a **renewable** energy source because the water is replenished by rainfall and the heat is continuously produced deep within the Earth. We won't run out of geothermal energy.

Geothermal energy is defined as heat from the Earth. It is a clean, renewable resource that provides energy in the United States and around the world. It is considered a renewable energy resource because the heat emanating from the interior of the Earth is essentially limitless. The heat continuously flowing from the Earth's interior is estimated to be equivalent to 42 million megawatts of power.5 One megawatt is equivalent to 1million watts, and can meet the power needs of about 1,000 homes. The interior of the Earth is expected to remain extremely hot for billions of year to come, ensuring an essentially limitless flow of heat. Geothermal power plants capture this heat and convert it to energy in the form of electricity. The picture below shows the source of geothermal electric power production, heat from the Earth. As depth into the Earth's crust increases, temperature increases as well.

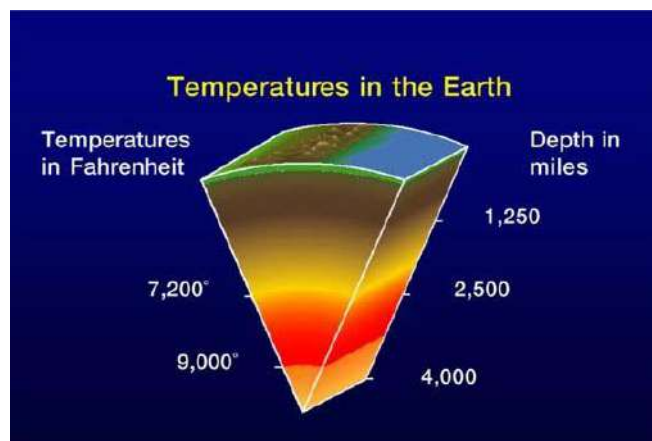

Figure 1: Earth's Temperatures

Like all forms of electric generation, both renewable and non-renewable, geothermal power generation has environmental impacts and benefits. By comparison to other forms of electricity generation, this paper highlights the benefits of choosing geothermal energy over other sources. Topics discussed include air emissions, noise pollution, water usage, land usage, waste disposal, subsidence, induced seismicity, and impacts on wildlife and vegetation. In addition, common environmental myths associated with geothermal energy are addressed throughout the paper. Geothermal energy, whether utilized in a binary, steam, or flash power plant, cooled by air or water systems, is a clean, reliable source of electricity with only minimal environmental impacts, even when compared with other renewable energy sources.

Wherever comparisons with other energy technologies are used, they are intended to provide a context for the reader. Every effort has been made to use comparable data from companies, industry groups, and government agencies. In providing these comparisons, we recognize that energy technologies have many different attributes, all of which should be considered

Converting Geothermal Energy into Electricity

Heat emanating from the Earth's interior and crust generates magma (molten rock). Because magma is less dense than surrounding rock, it rises but generally does not reach the surface, heating the water contained in rock pores and fractures. Wells are drilled into this natural collection of hot water or steam, called a geothermal reservoir, in order to bring it to the surface and use it for electricity production.

The three basic types of geothermal electrical generation facilities are binary, dry steam (referred to as .steam.), and flash steam (referred to as .flash.). Electricity production from each type depends on reservoir temperatures and pressures, and each type produces somewhat different environmental impacts. In addition, the choice of using water or air cooling technology in the power plants has economic and environmental trade-offs.

The most common type of power plant to date is a flash power plant with a water cooling system, where a mixture of water and steam is produced from the wells. The steam is separated in a surface vessel (steam separator) and delivered to the turbine, and the turbine powers a generator. In a dry steam plant like those at The Geysers in California, steam directly from the geothermal reservoir runs the turbines that power the generator, and no separation is necessary because wells only produce steam. Figure 2 shows a flash and dry steam plant.

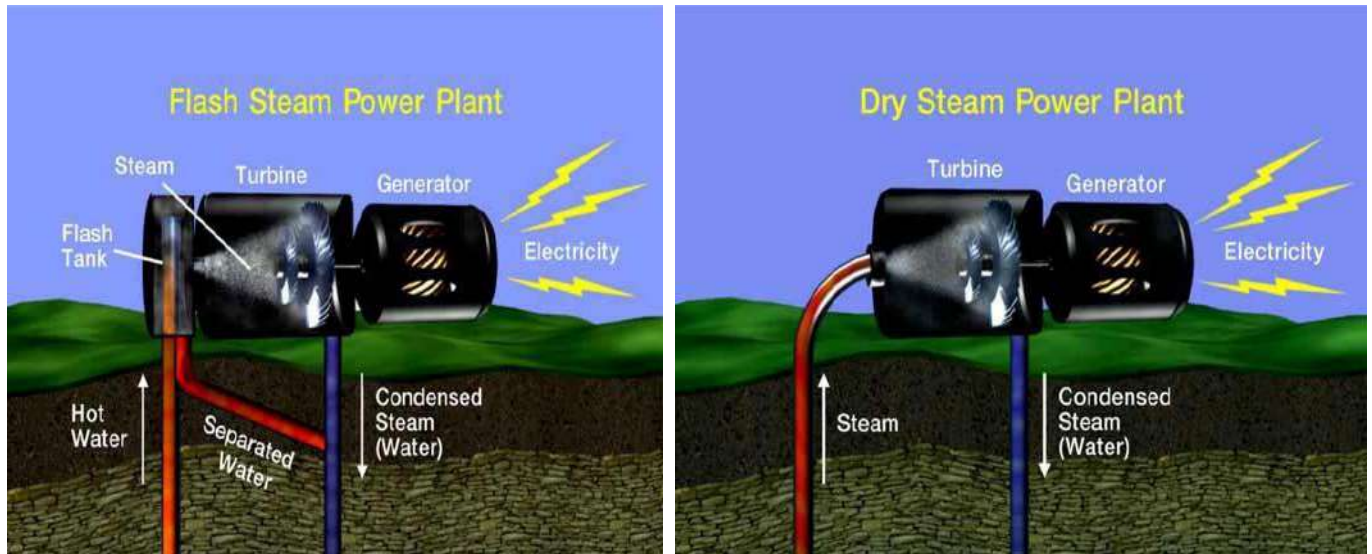

Figure 2: Flash and Dry Steam Power Plant Diagrams

Recent advances in geothermal technology have made possible the economic production of electricity from lower temperature geothermal resources, at 100°C (212°F) to 150°C (302°F). Known as binary geothermal plants, these facilities reduce geothermal energy's already low emission rate to near zero.

In the binary process, the geothermal water heats another liquid, such as isobutane, that boils at a lower temperature than water. The two liquids are kept completely separate through the use of a heat exchanger used to transfer the heat energy from the geothermal water to the "working-fluid." The secondary fluid vaporizes into gaseous vapor and (like steam) the force of the expanding vapor turns the turbines that power the generators. If the power plant uses air cooling (see next paragraph) the geothermal fluids never make contact with the atmosphere before they are pumped back into the underground geothermal reservoir, effectively making the plant emission free.

Developed in the 1980s, this technology is already in use in geothermal power plants throughout the world in areas that have lower resource temperatures. The ability to use lower temperature resources increases the number of geothermal reservoirs that can be used for power production. Figure 3 shows a binary power plant.

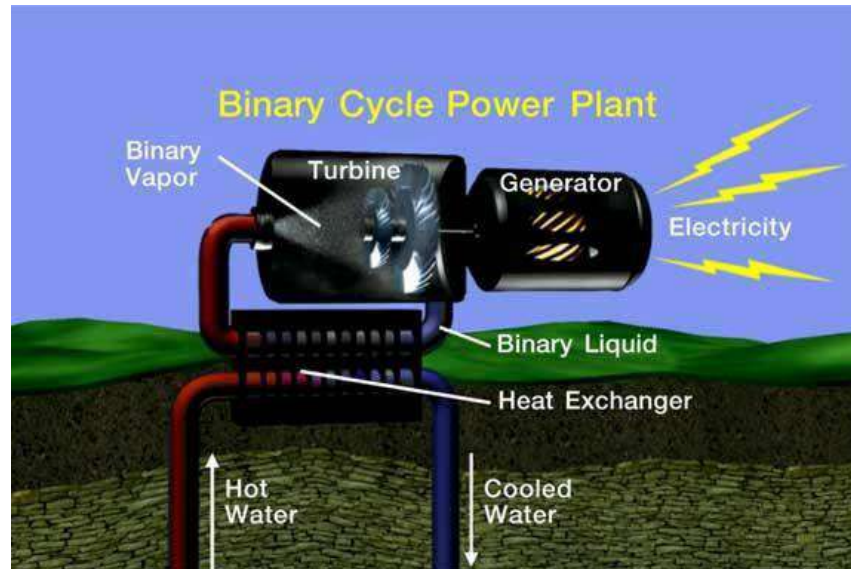

Figure 3: Binary Power Plant

A cooling system is essential for the operation of any modern geothermal power plant. Cooling towers prevent turbines from overheating and prolong facility life. Most power plants, including most geothermal plants, use water cooling systems. Figure 4 below shows a more complex diagram of a geothermal power plant, complete with a water(evaporative) cooling system. Figures 2 and 3 simplify the process of electricity production, while figure 4 shows greater detail and accuracy. Water cooled systems generally require less land than air cooled systems, and are considered overall to be effective and efficient cooling systems.

The evaporative cooling used in water cooled systems, however, requires a continuous supply of cooling water and creates vapor plumes. Usually, some of the spent steam from the turbine (for flash-and steam-type plants) can be condensed for this purpose. Air cooled systems, in contrast to the relative stability of water cooled systems, can be extremely efficient in the winter months, but are less efficient in hotter seasons when the contrast between air and water temperature is reduced, so that air does not effectively cool the organic fluid. Air cooled systems are beneficial in areas where extremely low emissions are desired, or in arid regions where water resources are limited, since no fluid needs to be evaporated for the cooling process.

Air cooled systems are preferred in areas where the view shed is particularly sensitive to the effects of vapor plumes, as vapor plumes are only emitted into the air by wet cooling towers and not air cooling towers. Most geothermal air cooling is used in binary facilities.

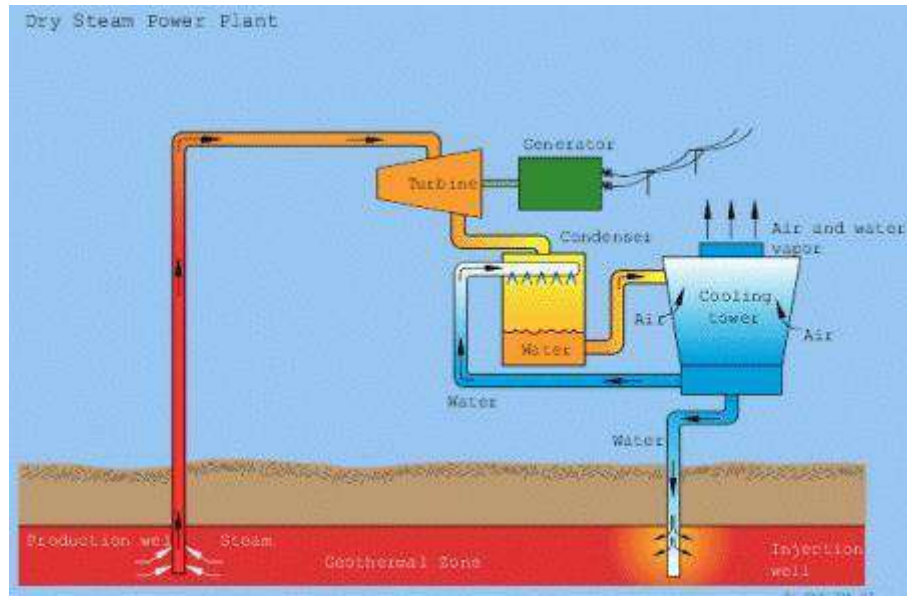

Figure 4: Geothermal Power Plant with Water Cooling System

A combination of flash and binary technology, known as the flash/binary combined cycle, has been used effectively to take advantage of the benefits of both technologies. In this type of plant, the flashed steam is first converted to electricity with a back pressure steam turbine, and the low-pressure steam exiting the backpressure turbine is condensed in a binary system. This allows for the effective use of air cooling towers with flash applications and takes advantage of the binary process. The flash/binary system has a higher efficiency where the well-field produces high pressure steam, while the elimination of vacuum pumping of non condensable gases allows for 100 percent injection.

OCEAN ENERGY

OTEC

Ocean thermal energy conversion (OTEC) generates electricity indirectly from solar energy by harnessing the temperature difference between the sun-warmed surface of tropical oceans and the colder deep waters. A significant fraction of solar radiation incident on the ocean is retained by seawater in tropical regions, resulting in average year-round surface temperatures of about 28°C. Deep, cold water, meanwhile, forms at higher latitudes and descends to flow along the sea shore toward the equator. The warm surface layer, which extends to depths of about 100–200 m, is separated from the deep cold water by a thermo cline. The temperature difference, T , between the surface and thousand-meter depth ranges from 10 to 25°C, with larger differences occurring in equatorial and tropical waters. It is that a differential of about 20°C is necessary to sustain viable operation of an OTEC facility.

Since OTEC exploits renewable solar energy, recurring costs to generate electrical power are minimal. However, the fixed or capital costs of OTEC systems per kilowatt of generating capacity are very high because large pipelines and heat exchangers are needed to produce relatively modest amounts of electricity. These high fixed costs dominate the economics of OTEC to the extent that it currently cannot compete with conventional power systems, except in limited niche markets. Considerable effort has been expended over the past two decades to develop OTEC by-products, such as fresh water, air conditioning, and mariculture, that could offset the cost penalty of electricity generation.

OTEC power systems operate as cyclic heat engines. They receive thermal energy through heat transfer from surface sea water warmed by the sun, and transform a portion of this energy to electrical power. The Second Law of Thermodynamics precludes the complete conversion of thermal energy into electricity. A portion of the heat extracted from the warm sea water must be rejected to a colder thermal sink. The thermal sink employed by OTEC systems is sea water drawn from the ocean depths by means of a submerged pipeline. A steady-state control volume energy analysis yields the result that net electrical power produced by the engine must equal the difference between the rates of heat transfer from the warm surface water and to the cold deep water. The limiting (i.e., maximum) theoretical Carnot energy conversion efficiency of a cyclic heat engine scales with the difference between the temperatures at which these heat transfers occur. For OTEC, this difference is determined by T and is very small; hence, OTEC efficiency is low. Although viable OTEC systems are characterized by Carnot efficiencies in the range of 6–8%, state-of-the-art combustion steam power cycles, which tap much higher temperature energy sources, are theoretically capable of converting more than 60% of the extracted thermal energy into electricity.

The low energy conversion efficiency of OTEC means that more than 90% of the thermal energy extracted from the ocean's surface is 'wasted' and must be rejected to the cold, deep sea water. This necessitates large heat exchangers and seawater flow rates to produce relatively small amounts of electricity. In spite of its inherent inefficiency, OTEC, unlike conventional fossil energy systems, utilizes a renewable resource and poses minimal threat to the environment. In fact, it has been suggested that widespread adoption of OTEC could yield tangible environmental benefits through avenues such as reduction of greenhouse gas CO₂ emissions; enhanced uptake of atmospheric CO₂ by marine organism populations sustained by the nutrient-rich, deep OTEC sea water; and preservation of corals and hurricane amelioration by limiting temperature rise in the surface ocean through energy extraction and artificial upwelling of deep water. Carnot efficiency applies only to an ideal heat engine. In real power generation systems, irreversibilities will further degrade performance. Given its low theoretical efficiency, successful implementation of OTEC power generation demands careful engineering to

minimize irreversibilities. Although OTEC consumes what is essentially a free resource, poor thermodynamic performance will reduce the quantity of electricity available for sale and, hence, negatively affect the economic feasibility of an OTEC facility. An OTEC heat engine may be configured following designs by J.A. D'Arsonval, the French engineer who first proposed the OTEC concept in 1881, or G. Claude, D'Arsonval's former student. Their designs are known, respectively, as closed cycle and open cycle OTEC.

Closed Cycle OTEC

D'Arsonval's original concept employed a pure working fluid that would evaporate at the temperature of warm sea water. The vapor would subsequently expand and do work before being condensed by the cold sea water. This series of steps would be repeated continuously with the same working fluid, whose flow path and thermodynamic process representation constituted closed loops and hence, the name 'closed cycle.' The specific process adopted for closed cycle OTEC is the Rankine, or vapor power, cycle. **Figure 1** is a simplified schematic diagram of a closed cycle OTEC system. The principal components are the heat exchangers, turbo generator, and seawater supply system, which, although not shown, accounts for most of the parasitic power consumption and a significant fraction of the capital expense. Also not included are ancillary devices such as separators to remove residual liquid downstream of the evaporator and subsystems to hold and supply working fluid lost through leaks or contamination.

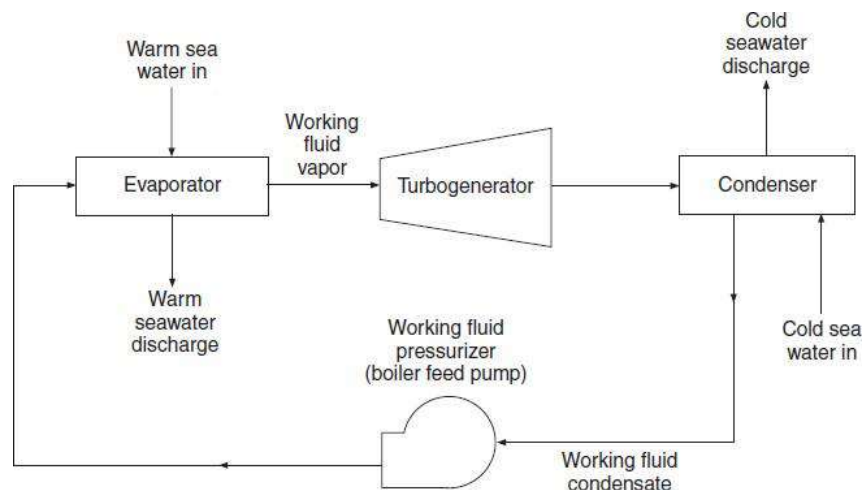

In this system, heat transfer from warm surface sea water occurs in the evaporator, producing a saturated vapor from the working fluid. Electricity is generated when this gas expands to lower pressure through the turbine. Latent heat is transferred from the vapor to the cold sea water in the condenser and the resulting liquid is pressurized with a pump to repeat the cycle. The success of the Rankine cycle is a consequence of more energy being recovered when the vapor expands through the turbine than is consumed in re-pressurizing the liquid. In conventional (e.g., combustion) Rankine systems, this yields net electrical power. For OTEC, however, the remaining balance may be reduced substantially by an amount needed to pump large volumes of sea water through the heat exchangers. (One misconception about OTEC is that tremendous energy must be expended to bring cold sea water up from depths approaching 1000 meters. In reality, the natural hydrostatic pressure gradient provides for most of the increase in the gravitational potential energy of a fluid particle moving with the gradient from the ocean depths to the surface.)

Irreversibilities in the turbo machinery and heat exchangers reduce cycle efficiency below the Carnot value. Irreversibilities in the heat exchangers occur when energy is transferred over a large

temperature difference. It is important, therefore, to select a working fluid that will undergo the desired phase changes at temperature established by the surface and deep sea water. Insofar as a large number of substances can meet this requirement (because pressures and the pressure ratio across the turbine and pump are design parameters), other factors must be considered in the selection of a working fluid including: cost and availability, compatibility with system materials, toxicity, and environmental hazard. Leading candidate working fluids for closed cycle OTEC applications are ammonia and various fluorocarbon refrigerants. Their primary disadvantage is the environmental hazard posed by leakage; ammonia is toxic in moderate concentrations and certain fluorocarbons have been banned by the Montreal Protocol because they deplete stratospheric ozone.

The Kalina, or adjustable proportion fluid mixture (APFM), cycle is a variant of the OTEC closed cycle. Whereas simple closed cycle OTEC systems use a pure working fluid, the Kalina cycle proposes to employ a mixture of ammonia and water with varying proportions at different points in the system. The advantage of a binary mixture is that, at a given pressure, evaporation or condensation occurs over a range of temperatures; a pure fluid, on the other hand, changes phase at constant temperature. This additional degree of freedom allows heat transfer-related irreversibilities in the evaporator and condenser to be reduced. Although it improves efficiency, the Kalina cycle needs additional capital equipment and may impose severe demands on the evaporator and condenser. The efficiency improvement will require some combination of higher heat transfer coefficients, more heat transfer surface area, and increased seawater flow rates. Each has an associated cost or power penalty. Additional analysis and testing are required to confirm whether the Kalina cycle and assorted variations are viable alternatives.

Open Cycle OTEC

Claude's concern about the cost and potential bio-fouling of closed cycle heat exchangers led him to propose using steam generated directly from the warm sea water as the OTEC working fluid. The steps of the Claude, or open, cycle are: (1) flash evaporation of warm sea water in a partial vacuum; (2) expansion of the steam through a turbine to generate power; (3) condensation of the vapor by direct contact heat transfer to cold sea water; and (4) compression and discharge of the condensate and any residual non condensable gases. Unless fresh water is a desired by-product, open cycle OTEC eliminates the need for surface heat exchangers. The name 'open cycle' comes from the fact that the working fluid (steam) is discharged after a single pass and has different initial and final thermodynamic states; hence, the flow path and process are 'open.' The essential features of an open cycle OTEC system are presented in **Figure 2**.

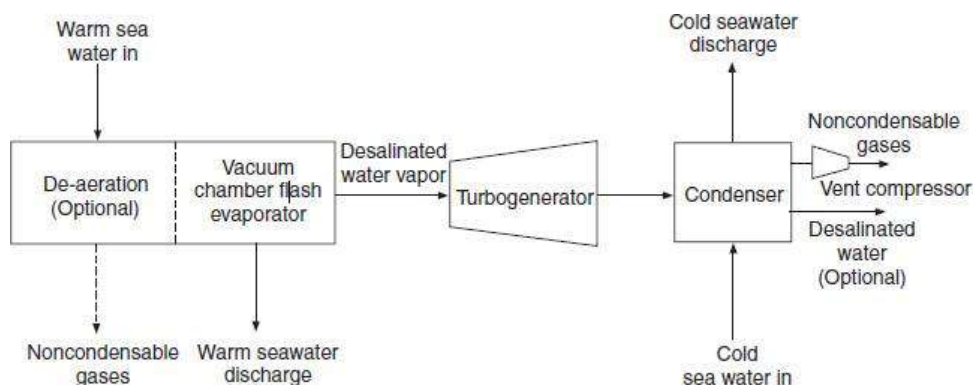

The entire system, from evaporator to condenser, operates at partial vacuum, typically at pressures of 1-3% of atmospheric. Initial evacuation of the system and removal of non condensable gases during operation are performed by the vacuum compressor, which, along with the sea water and discharge pumps, accounts for the bulk of the open cycle OTEC parasitic power consumption. The low system pressures of open cycle OTEC are necessary to induce boiling of the warm sea water. Flash evaporation is accomplished by exposing the sea water to pressures below the saturation pressure corresponding to its temperature.

This is usually accomplished by pumping it into an evacuated chamber through spouts designed to maximize heat and mass transfer surface area. Removal of gases dissolved in the sea water, which will come out of solution in the low-pressure evaporator and compromise operation, may be performed at an intermediate pressure prior to evaporation.

Vapor produced in the flash evaporator is relatively pure steam. The heat of vaporization is extracted from the liquid phase, lowering its temperature and preventing any further boiling. Flash evaporation may be perceived, then, as a transfer of thermal energy from the bulk of the warm sea water of the small fraction of mass that is vaporized. Less than 0.5% of the mass of warm sea water entering the evaporator is converted into steam.

The pressure drop across the turbine is established by the cold seawater temperature. At 43C, steam condenses at 813 Pa. The turbine (or turbine diffuser) exit pressure cannot fall below this value. Hence, the maximum turbine pressure drop is only about 3000Pa, corresponding to about a 3:1 pressure ratio. This will be further reduced to account for other pressure drops along the steam path and differences in the temperatures of the steam and seawater streams needed to facilitate heat transfer in the evaporator and condenser.

Condensation of the low-pressure steam leaving the turbine may employ a direct contact condenser (DCC), in which cold sea water is sprayed over the vapor, or a conventional surface condenser that physically separates the coolant and the condensate. DCCs are inexpensive and have good heat transfer characteristics because they lack a solid thermal boundary between the warm and cool fluids. Surface condensers are expensive and more difficult to maintain than DCCs; however, they produce a marketable freshwater by-product

Effluent from the condenser must be discharged to the environment. Liquids are pressurized to ambient levels at the point of release by means of a pump, or, if the elevation of the condenser is suitably high, can be compressed hydrostatically. As noted previously, non condensable gases, which include any residual water vapor, dissolved gases that have come out of solution, and air that may have leaked into the system, are removed by the vacuum compressor. Open cycle OTEC eliminates expensive heat exchangers at the cost of low system pressures.

Partial vacuum operation has the disadvantage of making the system vulnerable to air in-leakage and promotes the evolution of non condensable gases dissolved in sea water. Power must ultimately be expended to pressurize and remove these gases. Furthermore, as a consequence of the low steam density, volumetric Sow rates are very high per unit of electricity generated. Large components are needed to accommodate these Sow rates. In particular, only the largest conventional

steam turbine stages have the potential for integration into open cycle OTEC systems of a few megawatts gross generating capacity. It is generally acknowledged that higher capacity plants will require a major turbine development effort.

The mist lift and foam lift OTEC systems are variants of the OTEC open cycle. Both employ the sea water directly to produce power. Unlike Claude's open cycle, lift cycles generate electricity with a hydraulic turbine. The energy expended by the liquid to drive the turbine is recovered from the warm sea water. In the lift process, warm seawater is flash evaporated to produce a two-phase, liquid-vapor mixture and either a mist consisting of liquid droplets suspended in a vapor, or a foam, where vapor bubbles are contained in a continuous liquid phase. The mixture rises, doing work against gravity. Here, the thermal energy of the vapor is expended to increase the potential energy of the fluid. The vapor is then condensed with cold sea water and discharged back into the ocean. Flow of the liquid through the hydraulic turbine may occur before or after the lift process. Advocates of the mist and foam lift cycles contend that they are cheaper to implement than closed cycle OTEC because they require no expensive heat exchangers, and are superior to the Claude cycle because they utilize a hydraulic turbine rather than a low pressure steam turbine.

Hybrid Cycle OTEC

Some marketing studies have suggested that OTEC systems that can provide both electricity and water may be able to penetrate the marketplace more readily than plants dedicated solely to power generation. Hybrid cycle OTEC was conceived as a response to these studies. Hybrid cycles combine the potable water production capabilities of open cycle OTEC with the potential for large electricity generation capacities offered by the closed cycle.

Several hybrid cycle variants have been proposed. Typically, as in the Claude cycle, warm surface seawater is flash evaporated in a partial vacuum. This low pressure steam flows into a heat exchanger where it is employed to vaporize a pressurized, low-boiling-point fluid such as ammonia. During this process, most of the steam condenses, yielding desalinated potable water. The ammonia vapor flows through a simple closed-cycle power loop and is condensed using cold sea water. The uncondensed steam and other gases exiting the ammonia evaporator may be further cooled by heat transfer to either the liquid ammonia leaving the ammonia condenser or cold sea water. The non condensables are then compressed and discharged to the atmosphere. Steam is used as an intermediary heat transfer medium between the warm sea water and the ammonia; consequently, the potential for bio-fouling in the ammonia evaporator is reduced significantly. Another advantage of the hybrid cycle related to freshwater production is that condensation occurs at significantly higher pressures than in an open cycle OTEC condenser, due to the elimination of the turbine from the steam flow path. This may, in turn, yield some savings in the amount of power consumed to compress and discharge the non condensable gases from the system.

These savings (relative to a simple Claude cycle producing electricity and water), however, are offset by the additional back work of the closed-cycle ammonia pump. One drawback of the hybrid cycle is that water production and power generation are closely coupled. Changes or problems in either the water or power subsystem will compromise performance of the other. Furthermore, there is a risk that the potable water may be contaminated by an ammonia leak. In response to these concerns, an alternative hybrid cycle has been proposed, comprising decoupled and water production components.

The basis for this concept lies in the fact that warm sea water leaving a closed cycle evaporator is still sufficiently warm, and cold seawater exiting the condenser is sufficiently cold, to sustain an independent freshwater production process. The alternative hybrid cycle consists of a conventional closed-cycle OTEC system that produces electricity and a downstream Sash-evaporation-based desalination system. Water production and electricity generation can be adjusted independently, and either can operate should a subsystem fail or require servicing. The primary drawbacks are that the ammonia evaporator uses warm seawater directly and is subject to bio fouling; and additional equipment, such as the potable water surface condenser, is required, thus increasing capital expenses.

Tidal and Wave Energy

Tidal Power is the power of electricity generation achieved by capturing the energy contained in moving water mass due to tides. Two types of tidal energy can be extracted: **kinetic energy** of currents between ebbing and surging tides and **potential energy** from the difference in height between high and low tides.

All coastal areas experience high and low tide. If the difference between high and low tides is more than 16 feet, the differences can be used to produce electricity. There are approximately 40 sites on earth where tidal differences are sufficient. Tidal energy is more reliable than wave energy because it based on the moon and we can predict them. It is intermittent, generating energy for only 6-12 hours in each 24 hour period, so demand for energy will not always be in line with supply.

Types of Tidal Energy

Kinetic energy from the currents between ebbing and surging tides

>This form is considered most feasible

>Potential energy from height differences between high and low tide



Density of water is much higher than air, so ocean currents have much more energy than wind currents.

- Barrage or Dam
Using a dam to trap water in a basin, and when reaches appropriate height due to high tide, release water to flow through turbines that turn an electric generator.
- Tidal Fence
Turnstiles built between small islands or between mainland and islands. The turnstiles spin due to tidal currents to generate energy.
- Tidal turbine
Look like wind turbines, often arrayed in rows but are under water. Tidal currents spin turbines to create energy

Like wave energy, tidal energy is used for electricity, with the ultimate goal of connecting to local utility grids. A single 11-meter blade tidal turbine outside of Britain's Devon coast will be capable of generating 300 kW of electricity (enough to power approximately 75 homes)

Tidal turbine

Tidal turbines look like wind turbines. They are arrayed underwater in rows, as in some wind farms. The turbines function best where coastal currents run at between 3.6 and 4.9 knots (4 and 5.5 mph). In currents of that speed, a 15-meter (49.2-foot) diameter tidal turbine can generate as much energy as a 60-meter (197-foot) diameter wind turbine. Ideal locations for tidal turbine farms are close to shore in water depths of 20–30 meters (65.5–98.5 feet).

There are different types of turbines that are available for use in a tidal barrage. A bulb turbine is one in which water flows around the turbine. If maintenance is required then the water must be stopped which causes a problem and is time consuming with possible loss of generation. The La Rance tidal plant near St Malo on the Brittany coast in France uses a bulb turbine.

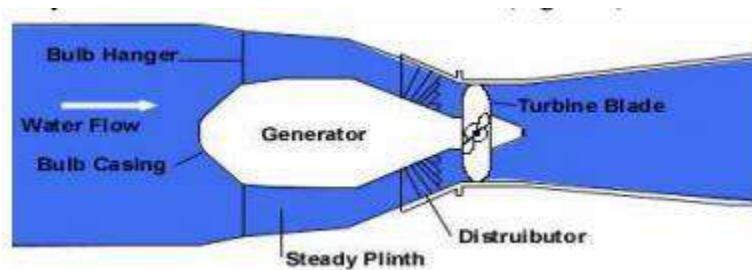

Bulb Turbine

When rim turbines are used, the generator is mounted at right angles to the turbine blades, making access easier. But this type of turbine is not suitable for pumping and it is difficult to regulate its performance. One example is the Straflo turbine used at Annapolis Royal in Nova Scotia.

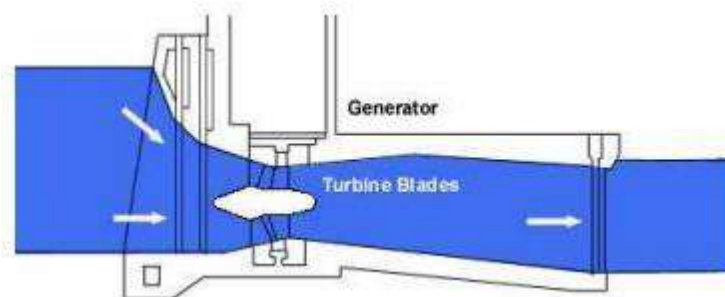

Rim Turbine

Tubular turbines have been proposed for the UK's most promising site, The Severn Estuary, the blades of this turbine are connected to a long shaft and are orientated at an angle so that the generator

is sitting on top of the barrage. The environmental and ecological effects of tidal barrages have halted any progress with this technology and there are only a few commercially operating plants in the world, one of these is the La Rance barrage in France.

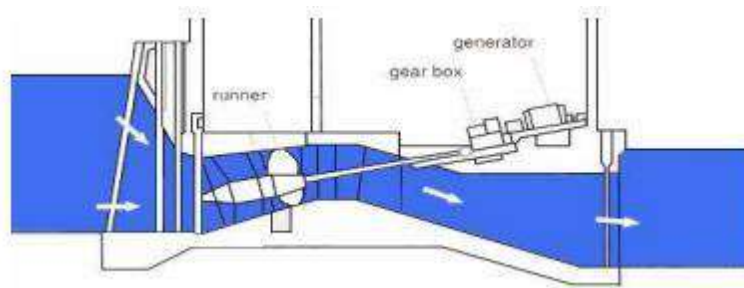

Tubular turbines

Category of generation

Ebb generation

The basin is filled through the sluices and freewheeling turbines until high tide. Then the sluice gates and turbine gates are closed. They are kept closed until the sea level falls to create sufficient head across the barrage and the turbines generate until the head is again low. Then the sluices are opened, turbines disconnected and the basin is filled again. The cycle repeats itself. Ebb generation (also known as outflow generation) takes its name because generation occurs as the tide ebbs.

Flood generation

The basin is emptied through the sluices and turbines generate at tide flood. This is generally much less efficient than Ebb generation, because the volume contained in the upper half of the basin (which is where Ebb generation operates) is greater than the volume of the lower half (the domain of Flood generation).

Two-way generation

Generation occurs both as the tide ebbs and floods. This mode is only comparable to Ebb generation at spring tides, and in general is less efficient. Turbines designed to operate in both directions are less efficient.

Pumping

Turbines can be powered in reverse by excess energy in the grid to increase the water level in the basin at high tide (for Ebb generation and two-way generation). This energy is returned during generation.

Two-basin schemes

With two basins, one is filled at high tide and the other is emptied at low tide. Turbines are placed between the basins. Two-basin schemes offer advantages over normal schemes in that generation time can be adjusted with high flexibility and it is also possible to generate almost continuously. In normal estuarine situations, however, two-basin schemes are very expensive to construct due to the cost of the extra length.

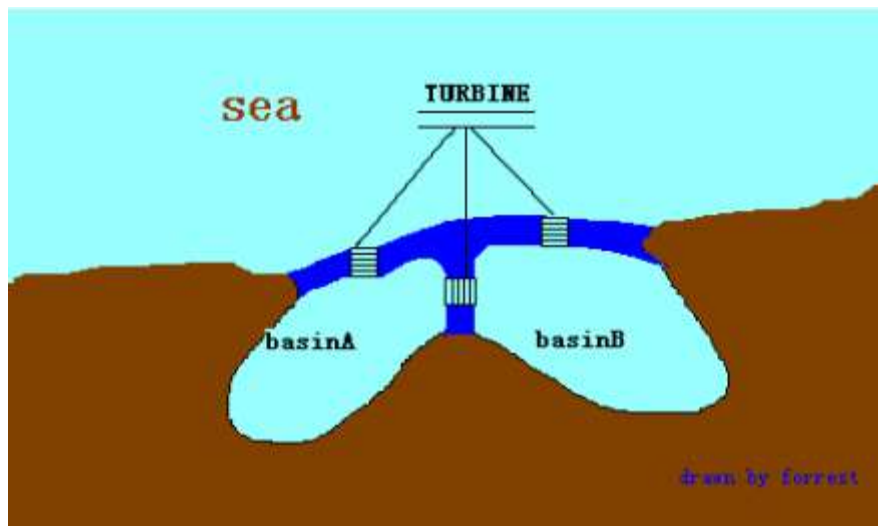

Schematic diagram of double basin tidal power generation

Wave Energy

Wave energy is an irregular and oscillating low frequency energy source that can be converted to a 50 Hertz frequency and can then be added to the electric utility grid. Waves get their energy from the wind, which comes from solar energy. Waves gather, store, and transmit this energy thousands of kilometers with very little loss. Though it varies in intensity, it is available twenty four hours a day all round the year. Wave power is renewable, pollution free and environment friendly. Its net potential is better than wind, solar, small hydro or biomass power. Wave energy technologies rely on the up-and-down motion of waves to generate electricity. There are three basic methods for converting wave energy to electricity.

1. **Float or buoy systems** that use the rise and fall of ocean swells to drive hydraulic pumps. The object can be mounted to a floating raft or to a device fixed on the ocean bed. A series of anchored buoys rise and fall with the wave. The movement is used to run an electrical generator to produce electricity which is then transmitted ashore by underwater power cables.
2. **Oscillating water column devices** in which the in-and-out motion of waves at the shore enters a column and force air to turn a turbine. The column fills with water as the wave rises and empties as it descends. In the process, air inside the column is compressed and heats up, creating energy. This energy is harnessed and sent to shore by electrical cable.

3. **Tapered channel** rely on a shore mounted structure to channel and concentrate the waves driving them into an elevated reservoir. Water flow out of this reservoir is used to generate electricity using standard hydropower technologies.

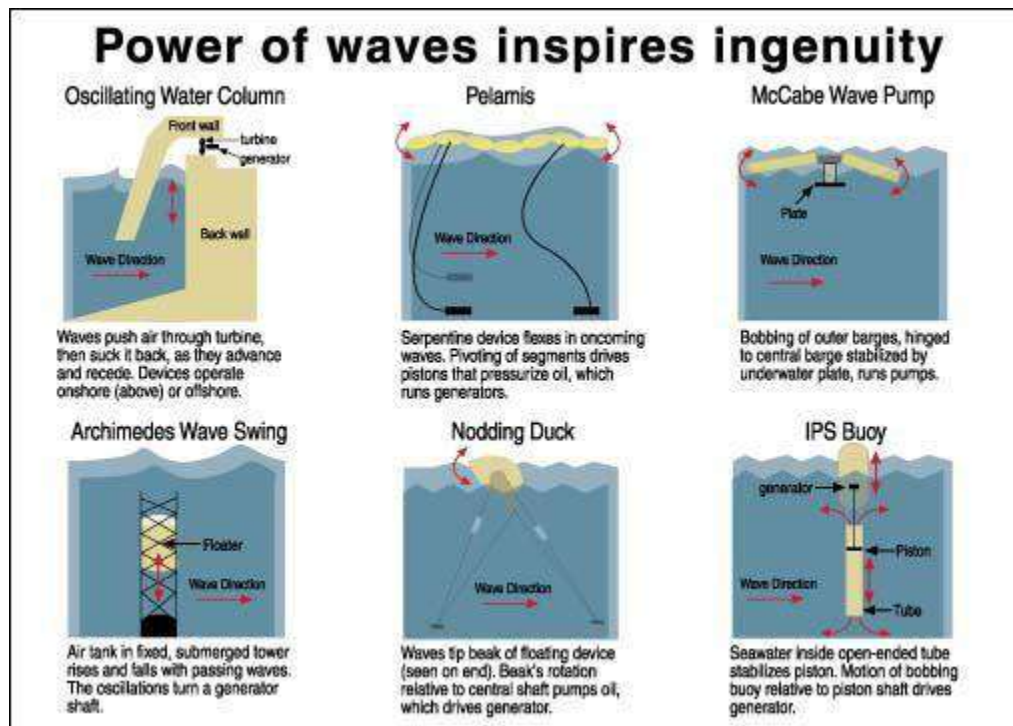

The advantages of wave energy are as follows:

1. Because waves originate from storms far out to sea and can travel long distances without significant energy loss, power produced from them is much steadier and more predictable day to day and season to season.
2. Wave energy contains about 1000 times the kinetic energy of wind.
3. Unlike wind and solar energy, energy from ocean waves continues to be produced round the clock.
4. Wave power production is much smoother and more consistent than wind or solar resulting in higher overall capacity factors.
5. Wave energy varies as the square of wave height whereas wind power varies with the cube of air speed. Water being 850 times as dense as air, this result in much higher power production from waves averaged over time.
6. Because wave energy needs only 1/200 the land area of wind and requires no access roads, infrastructure costs are less.



UNIT V

Direct Energy Conversion



UNIT – V

DIRECT ENERGY CONVERSION

It is the method of transformation of one type of energy into another without passing through the intermediate stage such as steam, generators etc. Most of these energy converters, sometimes called static energy-conversion devices, use electrons as their “working fluid” in place of the vapour or gas employed by such dynamic heat engines as the external combustion and internal-combustion engines mentioned above.

In recent years, direct energy-conversion devices have received much attention because of the necessity to develop more efficient ways of transforming available forms of primary energy into electric power. Direct energy-conversion devices are of interest for providing electric power in spacecraft because of their reliability and their lack of moving parts. As have solar cells, fuel cells, and thermoelectric generators, thermionic power converters have received considerable attention for space applications. Thermionic generators are designed to convert thermal energy directly into electricity.

Direct Energy Conversion devices like thermionic and thermoelectric converters are heat engines. The heat engine operates between two reservoirs to and from which heat can be transferred. We put heat into the system from the hot reservoir and heat is expelled into the cold reservoir.

The Carnot cycle:

The Carnot cycle is a theoretical thermodynamic cycle proposed by Nicolas Léonard Sadi Carnot. It can be shown that it is the most efficient cycle for converting a given amount of thermal energy into work, or conversely, creating a temperature difference (e.g. refrigeration) by doing a given amount of work. Every single thermodynamic system exists in a particular state. When a system is taken through a series of different states and finally returned to its initial state, a thermodynamic cycle is said to have occurred. In the process of going through this cycle, the system may perform work on its surroundings, thereby acting as a heat engine.

A system undergoing a Carnot cycle is called a Carnot heat engine, although such a “perfect” engine is only a theoretical limit and cannot be built in practice. The Carnot cycle when acting as a heat engine consists of the following steps:

1. Reversible isothermal expansion of the gas at the “hot” temperature, T_1 (isothermal heat addition or absorption). During this step the gas is allowed to expand and it does work on the surroundings. The temperature of the gas does not change during the process, and thus the expansion is isothermal. The gas expansion is propelled by absorption of heat energy Q_1 and of entropy $\Delta S = Q_1/T_1$ from the high temperature reservoir.

2. Isentropic (reversible adiabatic) expansion of the gas (isentropic work output). For this step the mechanisms of the engine are assumed to be thermally insulated, thus they neither gain nor lose heat. The gas continues to expand, doing work on the surroundings, and losing an equivalent amount of internal energy. The gas expansion causes it to cool to the “cold” temperature, T_2 . The entropy remains unchanged.

3. Reversible isothermal compression of the gas at the "cold" temperature, T_2 . (isothermal heat rejection) Now the surroundings do work on the gas, causing an amount of heat energy Q_2 and of entropy $\Delta S = Q_2/T_2$ to flow out of the gas to the low temperature reservoir. (This is the same amount of entropy absorbed in step 1, as can be seen from the Clausius inequality.)

4. Isentropic compression of the gas (isentropic work input). Once again the mechanisms of the engine are assumed to be thermally insulated. During this step, the surroundings do work on the gas, increasing its internal energy and compressing it, causing the temperature to rise to T_1 . The entropy remains unchanged. At this point the gas is in the same state as at the start of step 1.

Principles of DEC:

The pioneer in thermoelectrics was a German scientist Thomas Johann Seebeck (1770-1831) Thermoelectricity refers to a class of phenomena in which a temperature difference creates an electric potential or an electric potential creates a temperature difference. Thermoelectric power generator is a device that converts the heat energy into electrical energy based on the principles of Seebeck effect. Later, In 1834, French scientist, Peltier and in 1851, Thomson (later Lord Kelvin) described the thermal effects on conductors

Seebeck effect:

When the junctions of two different metals are maintained at different temperature, the emf is produced in the circuit. This is known as Seebeck effect.

Peltier effect:

Whenever current passes through the circuit of two dissimilar conductors, depending on the current direction, either heat is absorbed or released at the junction of the two conductors. This is known as Peltier effect.

Thomson effect:

Heat is absorbed or produced when current flows in material with a certain temperature gradient. The heat is proportional to both the electric current and the temperature gradient. This is known as Thomson effect.

Thermoelectric effect:

The thermoelectric effect, is the direct conversion of heat differentials to electric voltage and vice versa The good thermoelectric materials should possess large Seebeck coefficients, high electrical conductivity and low thermal conductivity

Principle, construction and working of Thermoelectric power generator:

Thermoelectric power generator based on the principle of Seebeck effect that when the junctions of two different metals are maintained at different temperature, the emf is produced in the circuit.

Construction:

Thermoelectric power generation (TEG) devices typically use special semiconductor materials, which are optimized for the Seebeck effect. The simplest thermoelectric power generator consists of a thermocouple, comprising a p-type and n-type material connected electrically in series and thermally in parallel. Heat is applied into one side of the couple and rejected from the opposite side. An electrical current is produced, proportional to the temperature gradient between the hot and cold junctions. For any TEPG, there are four basic component required such as Heat source (fuel), P and N type semiconductor stack ,Heat sink (cold side) and electrical load (output voltage)

Working:

When the two sides of semiconductor are maintained with different temperature, the emf flows across the output circuit

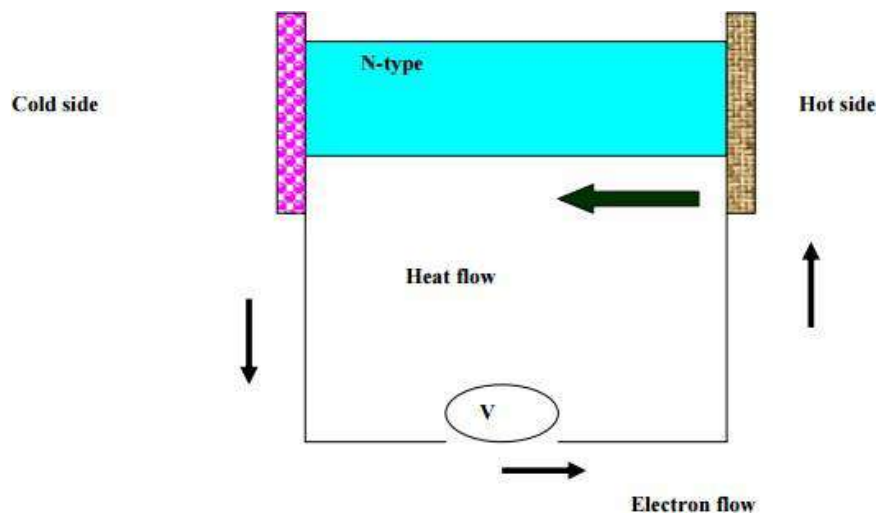

MAGNETO-HYDRODYNAMIC GENERATOR (MHD)

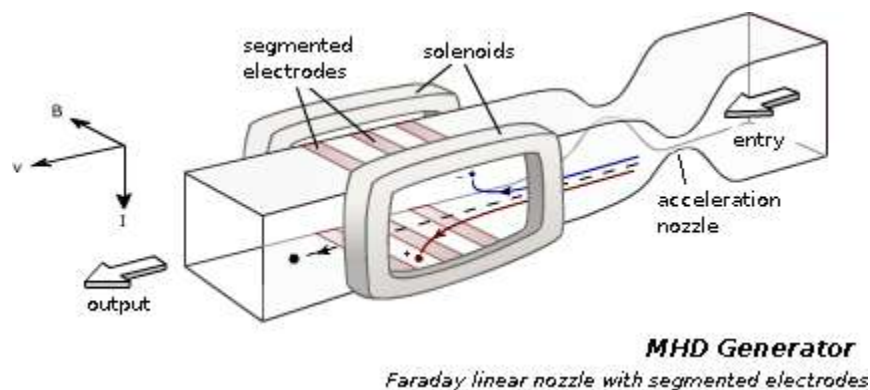

A magneto-hydrodynamic generator (MHD generator) is a magneto-hydrodynamic device that transforms thermal energy and kinetic energy into electricity. MHD generators are different from traditional electric generators in that they operate at high temperatures without moving parts. MHD was developed because the hot exhaust gas of an MHD generator can heat the boilers of a steam power

plant, increasing overall efficiency. MHD was developed as a topping cycle to increase the efficiency of electric generation, especially when burning coal or natural gas. MHD dynamos are the complement of MHDpropulsors, which have been applied to pump liquid metals and in several experimental ship engines.

An MHD generator, like a conventional generator, relies on moving a conductor through a magnetic field to generate electric current. The MHD generator uses hot conductive plasma as the moving conductor. The mechanical dynamo, in contrast, uses the motion of mechanical devices to accomplish this. MHD generators are technically practical for fossil fuels, but have been overtaken by other, less expensive technologies, such as combined cycles in which a gas turbine's or molten carbonate fuel cell's exhaust heats steam to power a steam turbine.

Principle of MHD Generation

The principal of **MHD power generation** is very simple and is based on Faraday's law of electromagnetic induction, which states that when a conductor and a magnetic field moves relative to each other, then voltage is induced in the conductor, which results in flow of current across the terminals.

As the name implies, the magneto hydro dynamics generator shown in the figure below, is concerned with the flow of a conducting fluid in the presence of magnetic and electric fields. In conventional generator or alternator, the conductor consists of copper windings or strips while in an MHD generator the hot ionized gas or conducting fluid replaces the solid conductor.

A pressurized, electrically conducting fluid flows through a transverse magnetic field in a channel or duct. Pair of electrodes are located on the channel walls at right angle to the magnetic field and connected through an external circuit to deliver power to a load connected to it. Electrodes in the MHD generator perform the same function as brushes in a conventional DC generator. The MHD generator develops DC power and the conversion to AC is done using an inverter.

The power generated per unit length by MHD generator is approximately given by,

$$P = \frac{\sigma u B^2}{P}$$

Where, u is the fluid velocity,

B is the magnetic flux density,

σ is the electrical conductivity of conducting fluid and

P is the density of fluid.

It is evident from the equation above, that for the higher power density of an MHD generator there must be a strong magnetic field of 4-5 tesla and high flow velocity of conducting fluid besides adequate conductivity.

MHD Cycles and Working Fluids

The **MHD cycles** can be of two types, namely

1. Open Cycle MHD.
2. Closed Cycle MHD.

Open Cycle MHD System

In open cycle MHD system, atmospheric air at very high temperature and pressure is passed through the strong magnetic field. Coal is first processed and burnt in the combustor at a high temperature of about 2700°C and pressure about 12 ATP with pre-heated air from the plasma. Then a seeding material such as potassium carbonate is injected to the plasma to increase the electrical conductivity. The resulting mixture having an electrical conductivity of about 10 Siemens/m is expanded through a nozzle, so as to have a high velocity and then passed through the magnetic field of MHD generator. During the expansion of the gas at high temperature, the positive and negative ions move to the electrodes and thus constitute an electric current. The gas is then made to exhaust through the generator. Since the same air cannot be reused again hence it forms an open cycle and thus is named as open cycle MHD.

Closed Cycle MHD System

As the name suggests the working fluid in a closed cycle MHD is circulated in a closed loop. Hence, in this case inert gas or liquid metal is used as the working fluid to transfer the heat. The liquid metal has typically the advantage of high electrical conductivity, hence the heat provided by the combustion material need not be too high. Contrary to the open loop system there is no inlet and outlet for the atmospheric air. Hence, the process is simplified to a great extent, as the same fluid is circulated time and again for effective heat transfer.

Advantages of MHD Generation

The advantages of MHD generation over the other conventional methods of generation are given below.

1. Here only working fluid is circulated, and there are no moving mechanical parts. This reduces the mechanical losses to nil and makes the operation more dependable.
2. The temperature of working fluid is maintained by the walls of MHD.
3. It has the ability to reach full power level almost directly.
4. The price of **MHD generators** is much lower than conventional generators.
5. MHD has very high efficiency, which is higher than most of the other conventional or non-conventional method of generation.

Fuel Cell: A fuel cell is an electric cell which produces electrical energy from chemical energy; through an oxidation reaction of provided fuel.

The main difference between normal secondary batteries and fuel cell is that; in secondary batteries the chemical energy is stored in the electrodes of the cell, but in Fuel cell the chemical energy is stored in a fuel. And the fuel, oxidizing agent are stored outside of the cell and fed into the cell when electricity is to be produced. Example of fuel cell is Hydrogen Fuel cell or Hydrogen-Oxygen Fuel cell.

Construction of a Fuel Cell:

A fuel cell consists of two porous electrodes separated by an electrolytic solution in between. The fuel which is usually Hydrogen or Carbon monoxide is fed into one of the electrodes and a Reacting agent; which is usually Oxygen or Air; is fed into another electrode. The electrodes are porous enough to pass through both fuels and electrolyte and also conduct electricity. The fuel and reacting agent reacts inside the fuel cell and produced electricity which can be obtained through terminals connected to the electrodes.

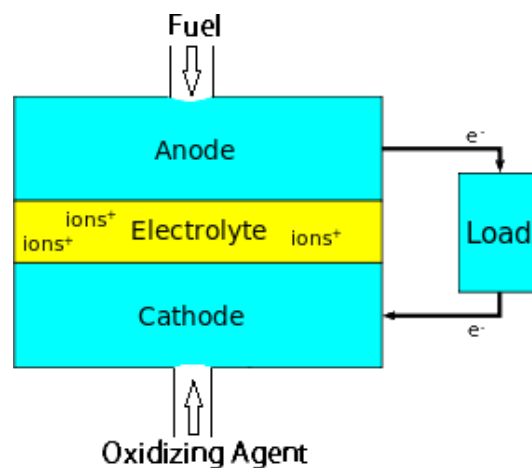

Advantages and Disadvantages of a Fuel Cell:

The electrode materials in a Fuel Cell are not changed during chemical reaction so a Fuel Cell does not require recharging, they can be used as a continuous generator as long as the fuel and oxidizing agent are supplied. Also, fuel cells do not have any moving parts; so, unlike normal generators they do not produce sound, require very little maintenance and produce no gases or fumes. Fuel cell's efficiency and cost per KW of power is independent of their size; so, they also offer a design flexibility and a room for further research and development.

But, the initial design and manufacturing cost of fuel cell is very high. They produce small voltages and also, their service life is not much as compared to other cells.

Hydrogen Fuel Cell:

Hydrogen Fuel cell or Hydrogen-Oxygen Fuel cell is one of the most basic types of fuel cell. Hydrogen fuel cell uses Hydrogen (H) as the fuel and Oxygen (O) is the oxidizing agent.

The basic construction of a Hydrogen-Oxygen Fuel cell is:

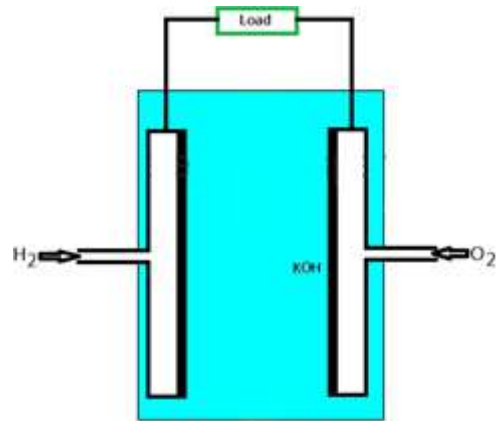

The electrodes are made up of sintered Nickel plates having a coarse pores surface and a fine pores surface ; the two surfaces for gas and electrolyte respectively. A solution of KOH is used as electrolyte. The water vapor formed during the reaction is passed back by condensation from the opening for passing hydrogen into the cell.

A continuous flow of Hydrogen and oxygen is maintained, The oxygen and hydrogen reacts with potassium hydroxide at the surface of electrodes to produce electricity.

Renewable energy sources

Assignments questions

UNIT-1

1. What is renewable energy?
2. Explain the need of renewable energy?
3. Classify the renewable energy sources?
4. What is energy storage management?
5. Explain the effect of use fossil fuel on Climate change and global warming?
6. Write and Explain sensible heat and latent heat?
7. What is green house effect?

UNIT -2

- 1 .Explain with neat figure solar radiation?
2. Explain sun and earth relationship in solar radiation?
3. Explain effect of sun and earth movement on solar radiation?
4. Explain concept of solar geometry?
5. Explain thermo syphon system for water heating?
6. Explain forced Circulation system in water heating's?
7. Explain flat plate collector with neat figure?
8. Explain evacuated tube collector with neat figure?
9. State application of solar thermal energy?
10. Explain brief P-V conversion?
11. Explain working principle of solar cells?
12. State the application of solar photovoltaic system?
13. Explain solar cooker?

UNIT 3

1. Write the characteristics of wind energy?
2. Describe the types of wind mills with sketches.
3. Details the bio mass conversion.
4. Explain the various types of bio gas digestors.
5. What are the types of wind mills?
6. Write the types of wind machines?

UNIT 4

1. Write the classification of Tidal power plants?
2. What are the Advantages and disadvantages of Geothermal Energy over other Energy forms?
3. Write the application of geothermal energy?
4. What are the five general categories of geothermal sources?
5. Define –Tidal power plant?
6. What are the advantages and limitation of Tidal power generation? Advantages.

UNIT 5

1. Define Seebeck effect?
2. What is working principle of thermionic?
3. Write a short notes on MHD –generator?
4. Write a short notes on Fuel cell?
5. Write the advantages of MHD systems?