

DEPARTMENT OF CIVIL ENGINEERING

4TH SEM.

**MANUAL FOR
SURVEYING LAB
I**

S.No.	List of Experiments
1	Survey of an area by Chain Survey (Closed Traverse) & Plotting
2	Chaining across Obstacles
3	Determination of two inaccessible points with Compass
4	Survey of a given area by Prismatic Compass (Closed Traverse) and plotting after adjustment
5	Radiation, Intersection Methods of Plane Table Surveying
6	Two Point and Three Point Problem in Plane Table Survey
7	Traversing by Plane Table Surveying
8	Fly Leveling (Differential Leveling)
9	An exercise of L.S. and L. S. and Plotting
10	Two Exercises on Contouring

FAMILARITY WITH INSTRUMENTS USED IN CHAIN SURVEYING

OBJECTIVE: Study of various instruments used in chain surveying and their uses

INSTRUMENTS:

- 1) Chain or tape
- 2) Arrows
- 3) Ranging rods
- 4) Cross staff
- 5) Offset rods
- 6) Pegs
- 7) Plumb bob

DESCRIPTION OF INSTRUMENTS:

1 a) Chain:

The chain is composed of 100 or 150 pieces of galvanized mild steel wire, 4mm in diameter called links. The ends of each link are bent into a loop and connected together by means of three oval rings. The ends of the chain are provided with handles for dragging the chain on the ground, each wire with a swivel joint so that the chain can be turned without twisting. The length of the chain is measured from the outside of one handle to the outside of another handle.

Following are the various types of chain in common use:

- 1) Metric chains
- 2) Gunter`s chain or surveyors chain
- 3) Engineers chain
- 4) Revenue chain
- 5) Steel band or Band chain

Metric chain:

Metric chains are made in lengths 20m and 30m. Tallies are fixed at every five-meter length and brass rings are provided at every meter length except where tallies are attached

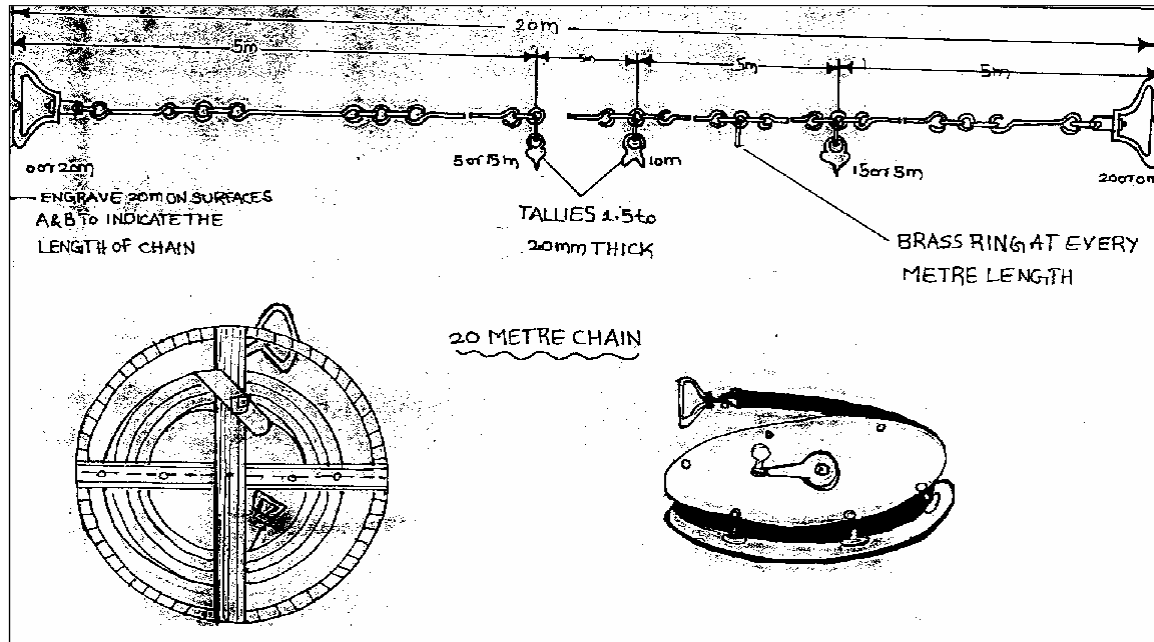

b) Tapes:

The following are the various types of tapes

- i) Cloth tape
- ii) Metallic tape
- iii) Steel tape
- iv) Invar tape

Among the above, metallic tapes are widely used in surveying. A metallic tape is made of varnished strip of waterproof line interwoven with small brass, copper or bronze wires. These are light in weight and flexible and are made 2m, 5m 10m, 20m, 30m, and 50m.

2. Arrows:

Arrows are made of good quality hardened steel wire of 4 mm diameter.

The arrows are made 400 mm in length, are pointed at one and the other end is bent into a loop or circle

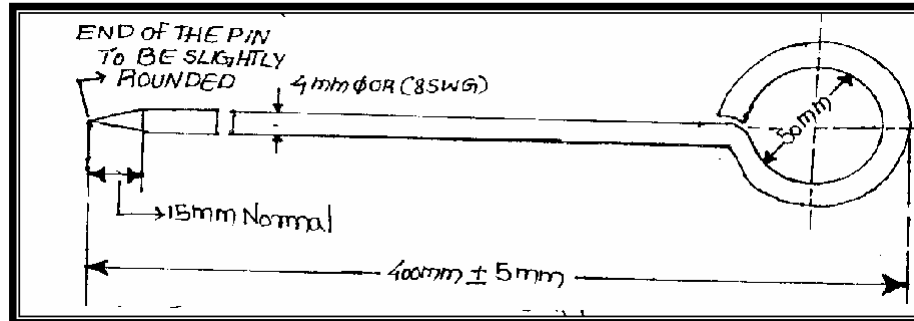

3. Ranging rods:

Ranging rods are used to range some intermediate points in the survey line. The length of the ranging rod is either 2m or 3m. They are shod at bottom with a heavy iron point. Ranging rods are divided into equal parts 0.2m long and they are painted alternately black and white or red and white or red, white and black. When they are at considerable distance, red and white or white and yellow flags about 25 cm square should be fastened at the top.

4. Cross staff: The simplest instrument used for setting out a right angle.

The common forms of cross staff are:

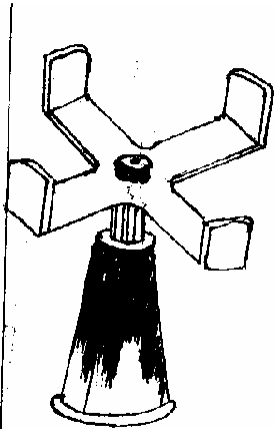
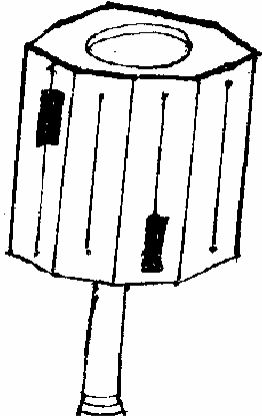
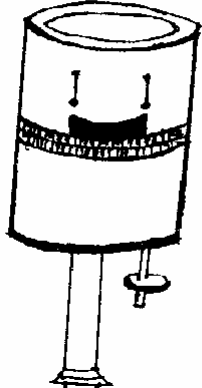
Open cross staff	French cross staff	Adjustable cross staff
		

5. **OFFSET ROD:**

The offset rod is used for measuring the off set of short lengths. It is similar to a ranging rod and is usually of 3m lengths.

6. **PEGS:**

These are rods made from hard timber and tapered at one end, generally 25mm or 30mm square and 150mm long wooden pegs are used to mark the position of the station on.

7. **PLUMB BOB:**

While chaining along sloping ground, a plumb bob is required to transfer the points to the ground.

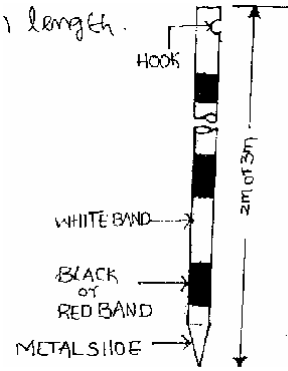
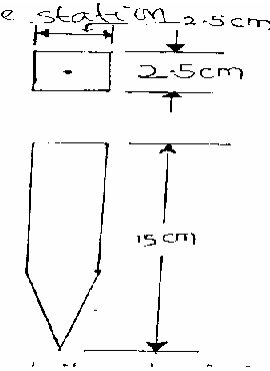
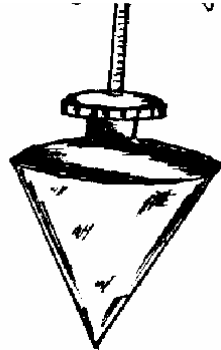
OFFSET ROD	PEGS	PLUMB BOB
 <p>1 length. HOOK WHITE BAND BLACK OR RED BAND METAL SHOE 3m of 3m</p>	 <p>2.5cm 2.5cm 15cm</p>	

PRACTICING UNFOLDING AND FOLDING OF A CHAIN

OBJECTIVE: To learnt the technique of unfolding and folding of a metric chain.

INSTRUMENTS: Metric chain

PROCEDURE:

UNFOLDING:

- » Remove the strap of the folded chain and take both the handles in the left hand and hold the remaining portion of the chain in the right hand.
- » Holding both the handles in the left hand, throw the remaining portion of the chain in the forward direction on the ground.
- » Now the follower stands at the starting station by holding one handle and directs the leader to move forward by holding the other handle until the chain is fully stretched.

FOLDING:

- » Bring the two handles together on the ground by pulling the chain at the center.
- » Commencing from the center two pairs of links are taken at a time with the right hand and placed alternatively in both directions in the left hand.
- » When the chain is completely folded the two brass handles will appear at the top.
- » Now tie the chain with leather strap.

EXPERIMENT NO. 01

CHAINING A LINE BY DIRECT RANGING

Surveyor:	Date:
Helpers:	Time:

OBJECTIVE: To measure the distance between two points on a level ground by ranging.

INSTRUMENTS:

Chain 20m / 30m	1 No.	Arrows	10 Nos.
Ranging rods	04 Nos.	Pegs	2 Nos.

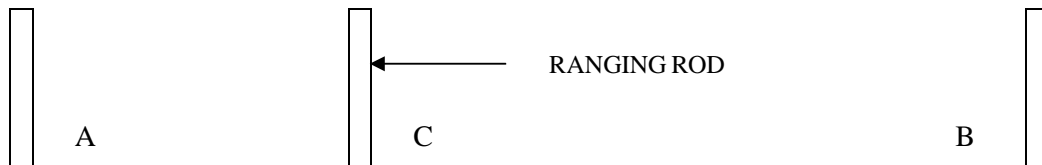

PROCEDURE:

- » Fix the ranging rods at the two given stations, where pegs are already driven on the ground.
- » The follower stand behind station A and directs the leader, with ranging rod to come in line with AB by signals of ranging

- » When the ranging rod comes in the line of AB the follower directs the leader to fix the ranging rod in position.
- » Let the intermediate point be C which should be less than 20m / 30 m .
- » Now the leader taken another ranging rod and stands between A and B about 2/3 distance from A
- » The follower directs the leader to come in line of AB by using signals of ranging.
- » As and when the point is located in the line of AB the follower instructs to fix the ranging rod in position.
- » Let the other intermediate position be D which is less than 20 m / 30 m from B
- » Now A, B, C and D are in one line.

Now the leader and follower measure the distance by measuring along A, C, D, B.

RESULT: The distance between AB = _____meter.

FIELD APPLICATION:

- » It can be extended to measure the lengths of more than two chain lengths.
- » By measuring the boundaries of given traverse the areas can be calculated.
- » The features can be located either by measuring oblique or perpendicular offset from the chain line.

EXPERIMENT NO. 02

CHAINING A LINE BY INDIRECT RANGING

Surveyor:	Date:
Helpers:	Time:

OBJECTIVE: Chaining a line when a hill or high ground intervenes preventing Intervisibility of ends of line.

INSTRUMENTS:

Chain 20m / 30m 1 No. Arrows 10 Nos.
Ranging rods 04 Nos.

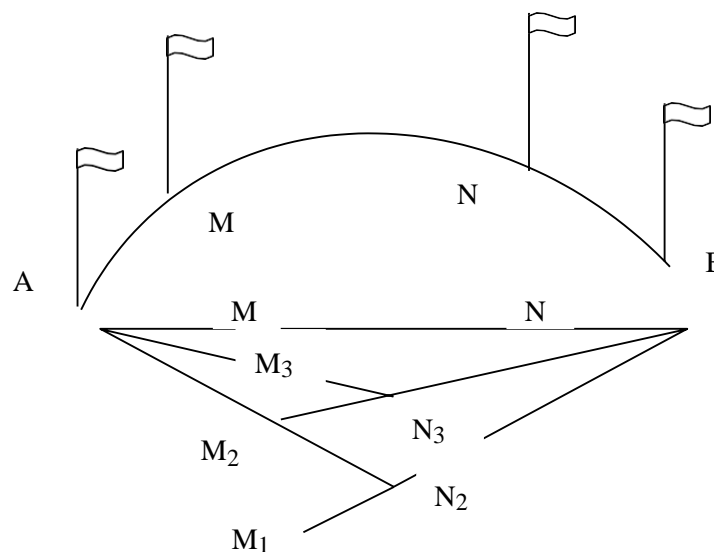

PROCEDURE:

- » Fix the two ranging rods at the given stations A and B which are not intervisible due to raising ground.
- » Select two intermediate points M₁ and N₁ such that from each point both A and B are visible.
- » The person at M₁ directs the person at N₁ to move to a new position N₂ in line with M₁B.
- » The person at N₂ then directs the person at M₁ to move to a new position M₂ in line with N₂A.
- » The person at M₂ directs the person at N₂ to a new position N₃ in line with M₂B.
- » The person at N₃ directs the person at M₂ to a new position M₃ in line with N₃A.
- » The process is repeated till the points M and N are located in such a way that M finds the person at N in line with AB and the person at N finds the person at M in line with AB.
- » After fixing the points M and N, other points are also fixed by direct ranging and the length of the line is measured.

Result:

Length of AM = _____ meter.
Length of MN = _____ meter.
Length of NB = _____ meter.

Therefore distance of AB = distance AM + distance MN + distance NB

EXPERIMENT NO. 03

MEASUREMENT OF AREA BY CHAIN TRIANGULATION

Surveyor:	Date:
Helpers:	Time:

OBJECTIVE: To measure the area of the given field by chain triangulation..

INSTRUMENTS:

Chain 20m / 30m 1 No. Arrows 10 Nos.
Ranging rods 6 Nos. Pegs 5 Nos.

SKETCH:

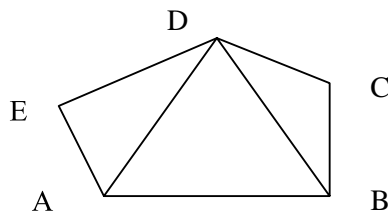

PROCEDURE:

- » Let ABCDE be the given field whose area is to be measured, fix the pegs at A, B, C, D & E.
- » Divide area into three triangles ADE, ABD and BCD by joining AD and BD.
- » Measure the lengths AB, BC, CD, DE, EA, AD and BD.
- » Calculate the area of the triangles.
- » The sum of the areas of the three triangles is the area of the given field.

FORMULA:

$$\text{Area of the triangle } \Delta = \sqrt{s(s-a)(s-b)(s-c)}$$

Where $S = (a + b + c) / 2$
A, b, c, are the sides of the triangle.

RESULT:

The area of the given field = _____ Square meter.

TOPIC – 2

COMPASS SURVEYING

1. Familiarity with instruments used in compass surveying – prismatic compass.
2. Setting up the compass – observation of bearings.
3. Traversing with prismatic compass and chain calculation of included angles and check.
4. Traversing with prismatic compass and chain closed traverse covering the given area recording.

FAMILIARITY WITH INSTRUMENTS USED IN COMPASS SURVEYING PRISMATIC COMPASS

OBJECTIVE: To identify different parts of prismatic compass and to know their functions

SKETCH:

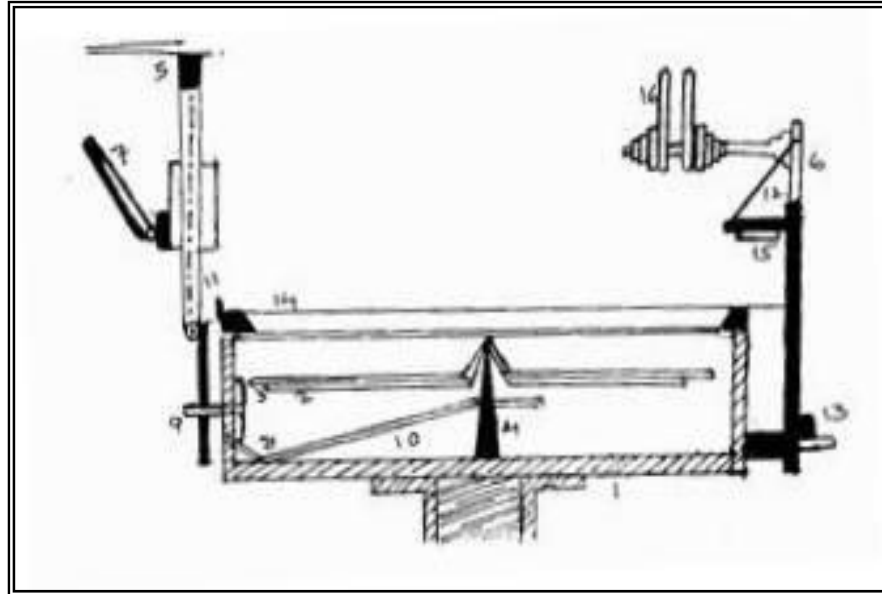

Parts List

- | | | |
|----------------------|--------------------|--------------------|
| 1. Compass Box | 2. Magnetic Needle | 3. Graduated Ring |
| 4. Pivot | 5. Objective Vane | 6. Eye Vane |
| 7. Adjustable Mirror | 8. Spring Brake | 9. Brake Pin |
| 10. Lifting Lever | 11. Lifting Pin | 12. Prism |
| 13. Focusing Stud | 14. Glass Cover | 15. Prism Dust Cap |
| 16. Sun Glasses | | |

DESCRIPTION OF INSTRUMENTS

COMPASS BOX: It is a circular box of diameter 85 to 110 mm having pivot at the center and covered with plain glass at top.

MAGNETIC NEEDLE: It facilitates in taking the bearings of survey lines with reference to the magnetic north.

GRADUATED RING: The bearings are marked inverted on the graduated rings from 0° to 360° in a clockwise starting 0° from south.

PIVOT: Magnet is freely held with this.

OBJECT VANE: It consists of prism with a sighting slit at the top. The prism magnifies and erects the inverted graduations.

BRAKE PIN: It is pressed to stop the oscillations of the graduated ring.

LIFTING PIN: On pressing it brings the lifting lever into action.

COLOUR GLASSES: Red and blue glasses are provided with the prism to sight luminous objects.

EXPERIMENT NO. 04

SETTING UP THE COMPASS – OBSERVATION OF BEARINGS

Surveyor:	Date:
Helpers:	Time:

OBJECTIVE : To perform station adjustments and to observe magnetic bearings using a prismatic compass.

INSTRUMENTS: Prismatic compass, tripod and ranging rods.

SKETCH:

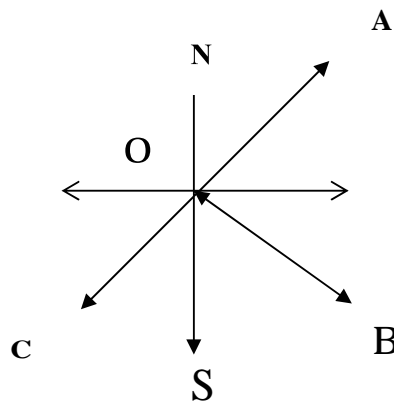

PROCEDURE:

The following station adjustments are to be done at each station where the compass is set up.

1. CENTERING:

- a. Centering is the process of keeping the prismatic compass over the station point.
- b. By moving the legs of the tripod suitably, centering will be done.
- c. Centering is checked by dropping a stone so that it falls on the top of the peg.

2. LEVELLING:

- a. Leveling is the process of making the compass exactly horizontal.
- b. Level the compass by means of ball and socket arrangements.
- c. When the compass is leveled, the aluminum ring swings freely.

3. FOCUSING:

To adjust the height of the prism so that the observations can be read clearly.

4. OBSERVING BEARINGS:

- a. Set up the prismatic compass over station 'O' and perform station adjustments.
- b. Rotate the compass till the line of sight bisects the object at 'A'.
- c. Read the graduated ring through prism. The reading directly gives the magnetic bearing of 'OA' in whole circle bearing system.
- d. Follow the same procedure to observe the magnetic bearings 'OB' 'OC' also.

5. TABULAR FORM:

Sl.No.	Station	Sighted to	W.C.B.

**TRAVERSING WITH PRISMATIC COMPASS AND CHAIN –
CALCULATION OF INCLUDED ANGLES**

Surveyor:	Date:
Helpers:	Time:

OBJECTIVE: To find the bearings of various station points and to calculate the included angles.

INSTRUMENTS: Prismatic compass, Tripod, Ranging rods, etc.

SKETCH:

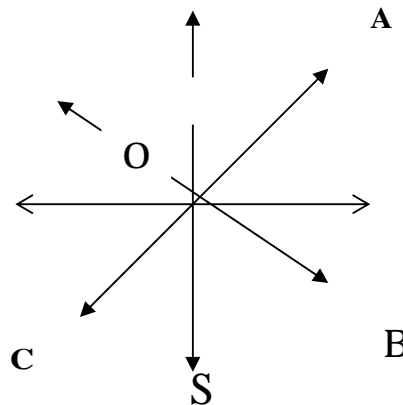

- » Let 'O' be the instrument station selected from which all other points are visible.
- » Complete all station adjustments like setting, centering and leveling accurately.
- » Sight the object 'A' looking through the prism vane, while the object vane is directed towards the object.
- » Observe the bearing by looking through the prism. Enter the readings in the tabular form.
- » Repeat the process at all objects stations B,C,D etc and enter the readings.

FORMULA:

Included angle: bearing of 2nd line bearing of first line.
(If the value is more than 180° than subtract the value from 360°).

TABULAR FORM

Sl.No.	Station	Sighted to	W.C.B.

* * *

EXPERIMENT NO. 06

TRAVERSING WITH PRISMATIC COMPASS AND CHAIN – CLOSED TRAVERSE COVERING THE AREA (Given) RECORDING

Surveyor:	Date:
Helpers:	Time:

OBJECTIVE : To conduct compass survey along the closed traverse.

INSTRUMENTS: Prismatic compass, chain, ranging rods.

SKETCH:

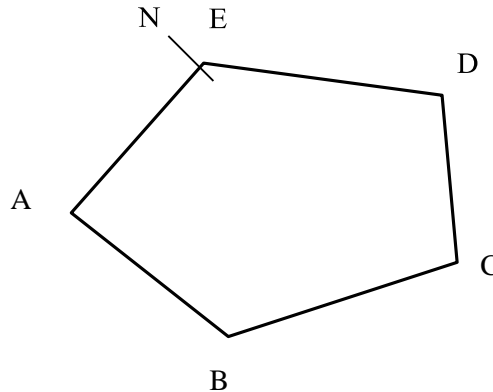

PROCEDURE:

- » Fix the closed traverse A B C D E .
- » Set up the compass at the station 'A'.
- » Perform the temporary adjustments.
- » Sight the object at 'B' and note down the FB of line AB and measure the distance.
- » Sight the object at E and note down the BB of EA.
- » Sight the instrument to station 'B' performs all the temporary adjustments.
- » Sight the object at 'A' and take the 'BB' of 'AB'.
- » Take 'FB' of 'BC' and measure the length of 'BC'.
- » Check whether the difference of 'FB' and 'BB' is 180° or not, at all stations.
- » Continue the same process all at other stations.

TABULAR FORM FOR CLOSED TRAVERSE

Sl.No.	Line	Length	F.B.	B.B	Remarks

FORMULA: Included angle = B.B of previous line – F.B of next line.

CHECK: The sum of the included angles should be equals to $(2n-4) \times 90^\circ$
Where 'n' is number of sides of the traverse.

TOPIC - 3

PLANE TABLE SURVEYING

- 1. Introduction to plane table equipment and accessories.**
- 2. Setting of the plane table and plotting a few objects (points) by radiation method**
- 3. Plotting building and other features of the campus by intersection method.**

INTRODUCTION TO PLANE TABLE EQUIPMENTS AND ACCESSORIES

OBJECTIVE: Study of plane table equipments and accessories.

INTRODUCTION TO PLANE TABLE:

Plane table surveying is a graphical method of surveying in which field work and plotting are done simultaneously in the field.

The plain table consists of the following:

1. Drawing board mounted on a tripod
2. Straight edge called an alidade.

THE DRAWING BOARD:

The board is made of well-seasoned wood and varies in size from 40cm x 30 cm to 75cm x 60cm or 50 – 60 cm square.

The Alidade:

The alidade consists of metal or box wood straight edge or ruler about 50cm long. The bevelled edge of the alidade is called the fiducially edge.

Accessories to the plane table

1. Trough compass
2. U – frame or plumbing fork
3. Water proof cover.
4. Spirit level or level tube
5. Drawing sheet
6. Pencil or eraser

Trough compass: The compass is used to mark the direction of the meridian on the paper.

U- frame or Plumbing fork:

U frame with a plumb bob used for centering the table.

Water Proof Cover:

Water Proof cover protects the sheet from rain.

Spirit level or level tube:

A level tube is used to level the plane table.

Drawing sheet:

The drawing sheet is fixed on the top of the drawing board.

Pencil and eraser:

A pencil is used for constructing lines and eraser is used for erasing lines after completion of the plan.

SETTING UP THE PLANE TABLE

The setting up the plane table includes the following three operations.

1. Centering the plane table
2. Leveling the plane table
3. Orientation of plane table

CENTERING THE PLANE TABLE:

The table should be set up at a convenient height for working say about 1m. The legs of tripod should be spread well apart and firmly fixed in to the ground. The table should be approximately leveled by tripod legs and judging by the eye.

Then the operation of centering is carried out by means of U-frame and plumb bob. The plane table is exactly placed over the ground station by U-frame and plumb bob.

LEVELING THE PLANE TABLE:

The process of leveling is carried out with the help of level tube. The bubble of level tube is brought to center in two directions, which are right angles to each other. This is achieved by moving legs.

ORIENTING THE TABLE:

The process of keeping the plane table always parallel to the position, which is occupied at the first station, is known as orientation. When the plane table is oriented, the lines on the board are parallel to the lines on the ground.

EXPERIMENT NO. 07

**SETTING OF THE PLANE TABLE AND PLOTTING A FEW OBJECTS
(POINTS) BY RADIATION METHOD**

SURVEY LAB:

DATE:

OBJECTIVE: Setting up the plane table and plotting a few objects by radiation method.

INSTRUMENTS:

- 1) Plane table
- 2) Tripod
- 3) Alidade

RADIATION: The plane table is set up over only one station from which the whole traverse can be commanded. It is suitable for survey of small areas.

SKETCH:

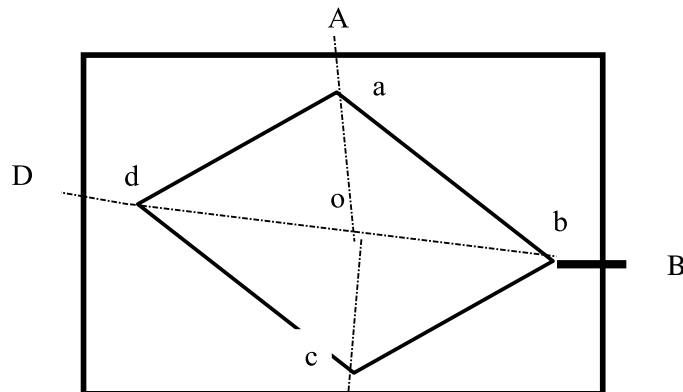

PROCEDURE:

- 1) Select a point "O" so that all points to be located are visible from it.
- 2) Set up the table at "O", level it, and do centering.
- 3) SELECT A POINT "O" on the sheet so that it is exactly over station "O" on the ground.
- 4) Mark the direction of the magnetic meridian
- 5) Centering the alidade on "O" BISECT the objects of traverse A, B, C and D.
- 6) Measure the distances OA, OB, OC and OD and plotted to convenient scale to locate a, b, c and d respectively
- 7) Join the points a, b, c and d on the paper.

**PLOTTING BUILDING AND OTHER FEATURES OF THE
COMPASS BY INTERSECTION METHOD**

SURVEY LAB:

DATE:

OBJECTIVE: Plotting building and other features of the compass by
Intersection method.

INSTRUMENTS:

- 1) Plane table
- 2) Tripod
- 3) Alidade

FIGURE

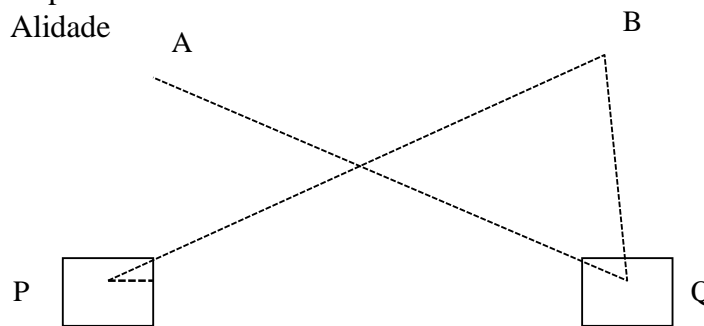

PROCEDURE:

- 1) Select two points P and Q such that the points (building corners) to be plotted are visible from their stations.
- 2) Set the table on P and locate on the sheet.
- 3) Pivot on P bisect Q draw a ray.
- 4) Measure the distance PQ and locate Q on the sheet to a convenient scale.
- 5) Now pq is known as the base line.
- 6) Pivot 'p' bisects the inaccessible objects A and B (building corners) and draw rays.
- 7) Shift the table to 'a' such that q is over Q and do temporary adjustments.
- 8) Place the alidade along qp and the rotate the table till p is bisected clamp table.
- 9) Pivot on q bisect the objects A and B and draw rays.
- 10) The intersection of rays drawn from P and Q will give the points a and b.
- 11) To check the accuracy measured AB and compare with plotted distance ab.
- 12) The same procedure is applied for other features of the campus. each point is bisected from two stations.

TOPICS - 4

LEVELLING

1. Study of dumpy level and leveling staff
2. Temporary adjustments of dumpy level.
3. Taking out levels of various points and booking in a level field book.
4. Differential or fly leveling-reduced levels by H-I method rise and fall method.

STUDY OF DUMPY LEVEL AND LEVELLING STAFF

OBJECTIVE: Study of components of dumpy level and leveling staff.

INSTRUMENTS: A level and leveling staff.

FIGURE:

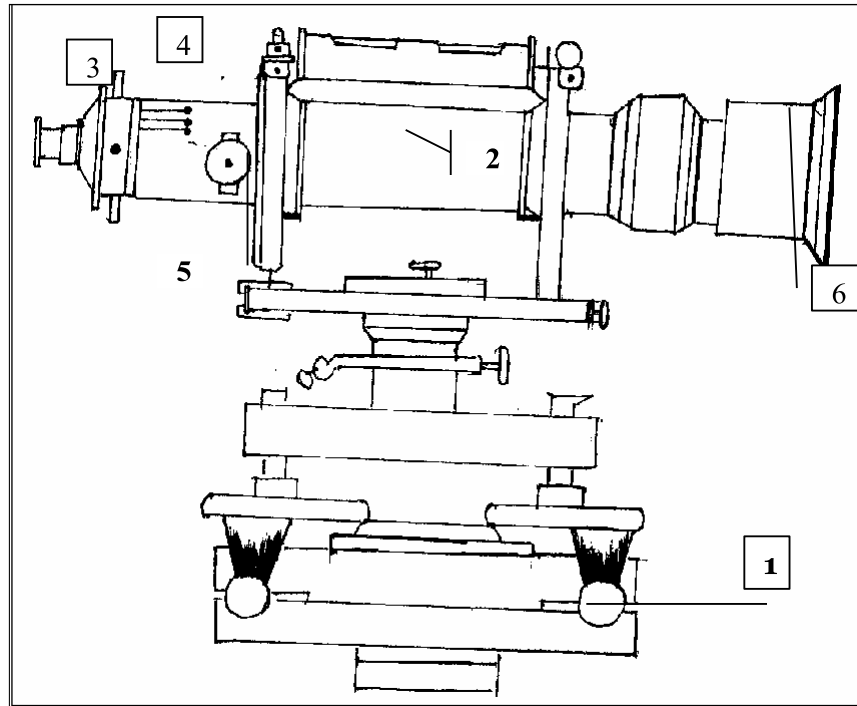

- | | |
|------------------|-------------------|
| 1. Leveling head | 4. Diaphragm |
| 2. Telescope | 5. Focusing screw |
| 3. Eye-piece | 6. Ray-shade |

The Major Components Of A Dumpy Level

TELESCOPE:

It contains of two metal tubes, one of which slides within the other one-tube carries the object glass and the second one carries eyepiece and diaphragm.

FOCUSSING SCREW:

The telescope is focused by turning the focusing screw either forward or backward.

BUBBLE TUBES:

The telescope is attached with two bubble tubes. One is longitudinal and the other is cross bubble tube. These two are placed at right angles to each other.

DIAPHRAGM:

It carries cross hairs.

TRIBRACH & TRIVET: The telescope with vertical spindle is supported by two parallel triangular plates. The upper plate is called tribrach and the lower plate is called trivet

FOOT SCREWS:

By turning the foot screws, the tribrach can be raised or lowered to bring the bubble to the center of its run.

LEVELLING STAFF:

THE LEVELLING STAFF:

It is used for measuring the vertical distance of the points above or below the horizontal line of sight. The different staves in use are

1. Sop with telescope staff
2. Folding staff
3. Solid staff
4. Target staff

SOP WITH TELESCOPE STAFF:

It is usually arranged in three telescopic lengths. The staff is 4m long when fully extended. The top length 1.25m is solid slides into the central box of length 1.25m, which again slides in the bottom box of 1.50m long. The staff is provided with brass spring catches to keep the extended length in position.

The meter numerals are marked on the left side and are pointed in red. The decimeter numerals are marked on the right side and are pointed in black.

The background is painted in white. The smallest division on this staff is 5mm. The graduations are marked erect and are seen inverted when viewed through the telescope.

FOLDING STAFF:

It is made of well-seasoned timber such as deodar, blue pine or aluminum. It is 4m long, 75mm wide, 18mm thick. It has two lengths of 2m each which are connected at the middle by a hinge so that the upper portion can be folded over the lower one. The minimum division on the staff is 5mm.

The lengths of meter in numerals are marked on the left and painted in black. The entire background is painted in white. The graduations are inverted and hence when viewed through the telescope, they appear erect.

SOLID STAFF:

It consists only one length and is usually 3m long. It is also graduated in divisions of 5mm. This is used for precise leveling work.

TARGET STAFF:

It consists of two lengths, one sliding over the other. It is graduated from top downwards. The target is equipped with vernier, which is adjusted by the staff man. The target is to be moved along the rod until its center is bisected by the line of sight. The target is then clamped and reading is taken. Target staves are used when the sights are long, say more than 100m.

TEMPORARY ADJUSTMENTS OF DUMPY LEVEL

OBJECTIVE: To obtain accurate results of leveling.

INSTRUMENTS: Dumpy level

PROCEDURE:

Temporary adjustments are to be made at each setup of the instrument. The following are the temporary adjustments to be made.

1. Setting up of the level
2. Leveling up
3. Elimination of parallax.

1. SETTING UP OF THE LEVEL

- i) Release the clamp screw of the instrument
- ii) Hold the instrument in the right hand and fix it on the tripod by turning round only the lower part with the left hand.
- iii) Screw the instrument firmly.
- iv) Bring all the foot screws to the center of its run.
- v) Spread the tripod legs well apart.
- vi) Fix any two legs firmly into the ground by pressing them with the hand.
- vii) Move the third leg to the right or left until the main bubble is approximately in the center.
- viii) Then move the third leg in or out until the bubbles of the cross-level is approximately in the center.
- ix) Fix the third leg firmly when the bubbles are approximately in the centers of their run.

2. LEVELLING UP

- i) Place the telescope parallel to a pair of foot screws.
- ii) Bring the bubble to the center of its run by turning the foot screws equally either both inwards and both outwards.
- iii) Turn the telescope through 90° so that it lies over the third foot screw.
- iv) Turn this third foot screw so that the bubble corners to the center of its run.
- v) Bring the telescope back to the original position without reversing the eye-piece and object glass.
- vi) Repeat the above operations until the bubble remains in the center of its run in both the positions.
- vii) Turn the telescope through 180° and check whether the bubble remains central.

3. ELIMINATION OF PARALLOX:

- i) Remove the lid from the object glass.
- ii) Hold a sheet of white paper in front of the object glass.
- iii) Move the eyepiece in or out until the cross hairs are distinctly visible.
- iv) Direct the telescope towards the staff.
- v) Turn the focusing screw until a clear and sharp image is formed in the plane of the cross hairs.

TABULAR FORM FOR HEIGHT OF INSTRUMENT (H.I) METHOD

Station	Readings			Height of Instrument	Reduced Level	Remarks
	Back sight	Inter Sight	Fore Sight			

$$H.I = R.L \text{ of B.M} + B.S$$

$$R.L \text{ of other station points} = H.I - I.S \text{ or F.S}$$

ARITHMATICAL CHECK:

$$\Sigma B.S - \Sigma F.S = \text{Last R.L} - \text{First R.L}$$

FOR RISE AND FALL METHOD

Station	Readings			Rise	Fall	R.L	Remarks
	Back sight	Inter Sight	Fore Sight				

ARITHMATICAL CHECK:

$$\Sigma B.S - \Sigma F.S = \Sigma \text{ Rise} - \Sigma \text{ Fall} = \text{Last R.L.} - \text{First R.L.}$$

TOPIC-5

THEODOLITE SURVEYING

1. Study of Theodolite
2. Measure of Horizontal angle between given lines
3. Measurement of vertical angle
4. Determining distance between two in accessible points by measuring horizontal angle
5. Determining an height of object by measuring vertical angle

STUDY OF TRANSIT THEODOLITE

OBJECTIVE : To study different parts of transit Theodolite and Temporary adjustments.

EQUIPEMNTNS: Transit - Theodolite

FIGURE

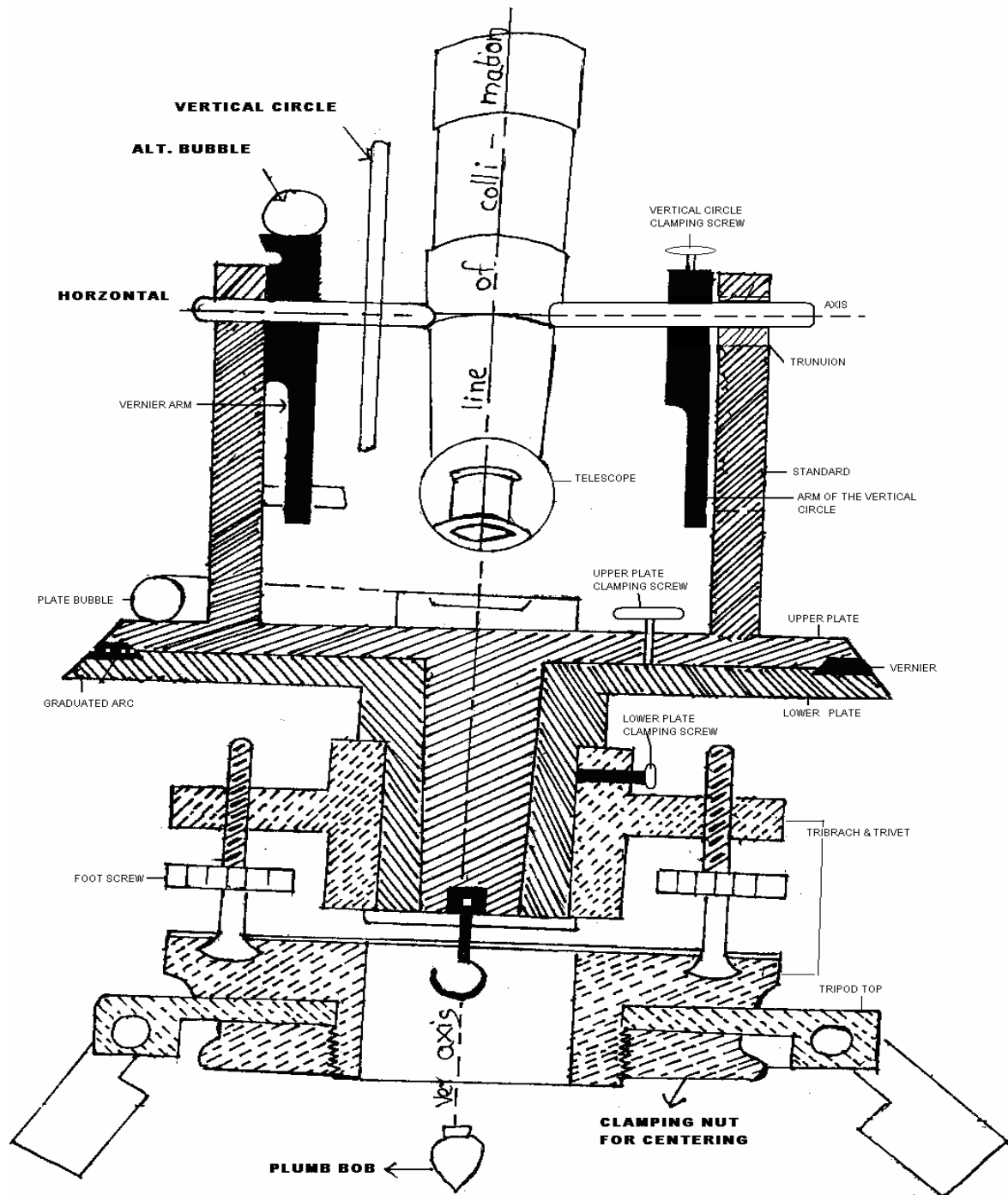

DEFINITION AND TERMS

VERTICAL AXIS:

It is the axis about which the telescope can be rotated in a horizontal plane.

HORIZONTAL AXIS:

It is the axis about which the telescope can be rotated in a vertical plane.

LINE OF COLLINATION:

It is the imaginary line joining the intersection of the cross hairs of the diaphragm to the optical center of the object glass and its continuation.

AXIS OF THE TELESCOPE:

It is the line joining the optical center of the object glass to the center of the eye-piece.

AXIS OF THE LEVEL TUBE:

It is the straight line tangential to the longitudinal curve of the level tube at the center of the tube.

CENTERING:

The process of setting the theodolite exactly over the station mark is known as centering.

TRANSITING:

It is the process of turning the telescope in vertical plane through 180° about the trunnion axis.

DESCRIPTION OF EQUIPMENT:

TELESCOPE:

It consists of eye-piece, object glass and focusing screw and it is used to sight the object.

VERTICAL CIRCLE:

It is used to measure vertical angles.

LEVELLING HEAD:

It consists of two parallel triangular plates called tribrach plates.

Its uses are

1. To support the main part of the instrument.
2. To attach the theodolite to the tripod.

LOWER PLATE:

It consists of lower clamp screw and tangent screw.

UPPER PLATE:

The upper plate is attached to the inner axis and it carries two verniers. It consists of an upper clamp screw and tangent screws. These screws are used to fix upper plate with lower plate accurately.]

FOOT SCREWS:

These are used to level the instrument

PLUMB BOB:

It is used to center theodolite exactly over the ground station mark.

SWINGING THE TELESCOPE:

It means turning the telescope about its vertical axis in the horizontal plane. A swing is called right or left according as the telescope is rotated clockwise or counter clockwise.

FACE LEFT:

If face of the vertical circle is to the left side of the observer, then the observation of the angles taken is known as face left observation.

FACE RIGHT:

If the face of the vertical circle is to the right side of the observation, then the observation of the angles taken is known as face right observation.

CHANGING FACE:

It is an operation of bringing the face of the telescope from left to right and vice-versa.

TEMPORARY ADJUSTMENTS:

There are three temporary adjustments of a theodolite. These are

1. Setting up the theodolite over a station.
2. Leveling up.
3. Elimination of parallax.

SETTING UP:

It includes two operations

1. Centering a theodolite over a station: Done by means of plumb bob.
2. Approximately leveling it by tripod legs only: Done by moving tripod legs radially or circumferentially.

LEVELING UP:

Having centered and approximately leveled the instrument, accurate leveling is done with the help of foot screws with reference to the plate levels, so that the vertical axis shall be truly vertical.

To level the instrument the following operations have to be done.

1. Turn the upper plate until the longitudinal axis of the plate level is roughly parallel to a line joining any two of the leveling screws (A & B).

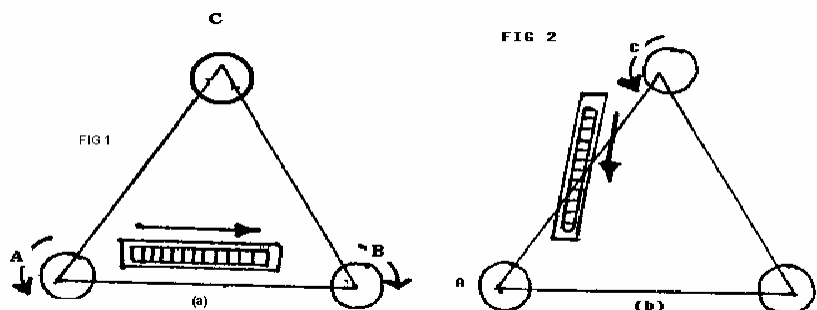
FIGURE:

2. Hold these two leveling screws between the thumb and first finger of each hand uniformly so that the thumb moves either towards each other or away from each other until the bubble comes to the center.

3. Turn the upper plate through 90° i.e until the axes of the level passes over the position of the third leveling screw 'C'.
4. Turn this leveling screw until the bubble comes to the center.
5. Rotate the upper plate through 90° to its original position fig(a) and repeat step(2) till the bubble comes to the center.
6. Turn back again through 90° and repeat step 4 .
7. Repeat the steps 2 and 4 till the bubble is central in both the positions.
8. Now rotate the instrument through 180° . The bubble should be remaining in the center of its run, provided it is in correct adjustment. The vertical axis will then be truly vertical.

3. ELIMINATION OF PARALLAX:

Parallax is a condition arising when the image formed by the objective is not in the plane of the cross hairs. Unless parallax is eliminated, accurate sighting is not possible. Parallax can be eliminated in two steps.

a. FOCUSING THE EYE-PIECE:

Point the telescope to the sky or hold a piece of white paper in front of the telescope. Move the eyepiece in and out until a distant and sharp black image of the cross-hairs is seen.

b. FOCUSING THE OBJECT:

Telescope is now turned towards object to be sighted and the focusing screw is turned until image appears clear and sharp.

MEASUREMENT OF HORIZONTAL ANGLE BY REPETITION METHOD

OBJECTIVE: To measure a horizontal angle by repetition method.

THEORY: In this method, the angle is added several times mechanically and the value of the angle obtained by dividing the accumulated reading by the number of repetitions.

EQUIPMENTS USED: Transit theodolite, tripod and ranging rods(2no.s).

SKETCH:

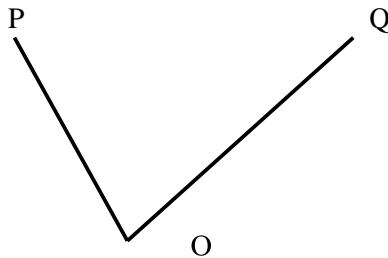

PROCEDURE:

1. Set up the instrument over 'O' and level it accurately.
2. With the help of upper clamp and tangent screw, set 0° reading on vernier 'A'. Note the reading of vernier 'B'.
3. Release the upper clamp and direct the telescope approximately towards the point 'P'. Tighten the lower clamp and bisect point 'P' accurately by lower tangent screw.
4. Release the upper clamp and turn the instrument clock-wise towards Q. Clamp the upper clamp and bisect 'Q' accurately with the upper tangent screw. Note the readings of verniers 'A' and 'B' to get the values of the angle POQ.
5. Release the lower clamp and turn the telescope clockwise to sight P again. Bisect P by using the lower tangent screw.
6. Release the upper clamp, turn the telescope clockwise and sight Q. Bisect Q by using the upper tangent screw.
7. Repeat the process until the angle measured (required number of times is 3). The average angle with face left will be equal to final reading divided by three.
8. Change face and make three more repetitions as described above. Find the average angle with face right, by dividing the final reading by three.
9. The average horizontal angle is then obtained by taking the average of the two angles with face left and face right.

Average horizontal angle		“ Sec	
		‘ Min	
		.o Deg.	
Horizontal Angle		“ Sec	
		‘ Min	
		.o Deg.	
No. Of Repetitions			
FACE: RIGHT	Mean	“ Sec	
		‘ Min	
		.o Deg.	
	B	“ Sec	
		‘ Min	
	A	“ Sec	
		‘ Min	
		.o Deg.	
	Horizontal angle	“ Sec	
		‘ Min	
		.o Deg.	
	No. Of Repetitions		
FACE: LEFT	Mean	“ Sec	
		‘ Min	
		.o Deg.	
	B	“ Sec	
		‘ Min	
	A	“ Sec	
		‘ Min	
		.o Deg.	
	Sighted to		
Instrumented to			

MEASUREMENT OF HORIZONTAL ANGLE BY REITERATION METHOD

OBJECTIVE : To measure horizontal angle by reiteration method.

EQUIPMENTS: Transit Theodolite , Tripod and Ranging rods.

SKETCH:

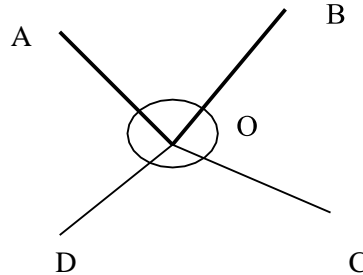

PROCEDURE:

If it is required to measure angles AOB, BOC, and COD etc by reiteration method

The following steps are to be used.

1. Set the instrument over “O” and level it set the Vernier to zero and bisect point A accurately.
2. Loose the upper clamp and turn the Telescope clockwise to point B. Bisect B by using the upper tangent screw. Read both the Verniers, the mean of the Verniers will give the angles AOB.
3. Similarly, bisect successively C, D etc, thus closing the circle. Read both the Verniers at each bisection.
4. Finally sight to A the reading of the vernier should be the same as the original setting reading.

Repeat the steps 02 to 04 with other face i.e. face Right.

Tabular Form

Average horizontal angle		“ Sec		
		‘ Min		
		.o Deg.		
Horizontal Angle		“ Sec		
		‘ Min		
		.o Deg.		
FACE: RIGHT SWING: LEFT	Mean	“ Sec		
		‘ Min		
		.o Deg.		
	B	“ Sec		
		‘ Min		
		.o Deg.		
	A	“ Sec		
		‘ Min		
		.o Deg.		
	Horizontal angle	“ Sec		
		‘ Min		
		.o Deg.		
FACE: LEFT SWING: RIGHT	Mean	“ Sec		
		‘ Min		
		.o Deg.		
	B	“ Sec		
		‘ Min		
		.o Deg.		
	A	“ Sec		
		‘ Min		
		.o Deg.		
	Sighted to			
	Instrumented to			

MESUREMENT OF VERTICAL ANGLES

SURVEYING LAB

DATE :

OBJECTIVE : To measure the Vertical angle of an object with respect to instrument station or any other point.

EQUIPMENTS : Theodolite and stand.

THEORY: A vertical angle is the angle between the inclined line of sight and the horizontal.

PROCEDURE:

To measure the Vertical angle of an object A at a station "O".

1. Set up the instrument over 'O' and level it with reference to the altitude bubble.
2. Set the zero of the vertical vernier exactly to the zero of the vertical circle by Means of the vertical circle clamp and tangent screw.
3. Bring the bubble of the altitude level to the center of its run. The line of Collimation is thus made horizontal, while the vernier reads zero.
4. Loosen the vertical circle clamp, direct the telescope towards the object 'A', and sighted approximately, clamp the vertical circle and bisect 'A' exactly by turning the tangent screw.
5. Read both venires. The mean of the two, readings gives the value of the required angle.
6. Change the face of the instrument and repeat the process. The mean of the two vernier readings gives the second value of the required angle.

To measure the vertical angle between the two points A and B

1. Bisect 'A' as before and note the readings on the vertical circle.
2. Similarly, bisect 'B' and note the readings on the vertical circle.
3. The sum or difference of these readings will give the value of the angle between A & B as one of the points is above and the other below the horizontal plane.

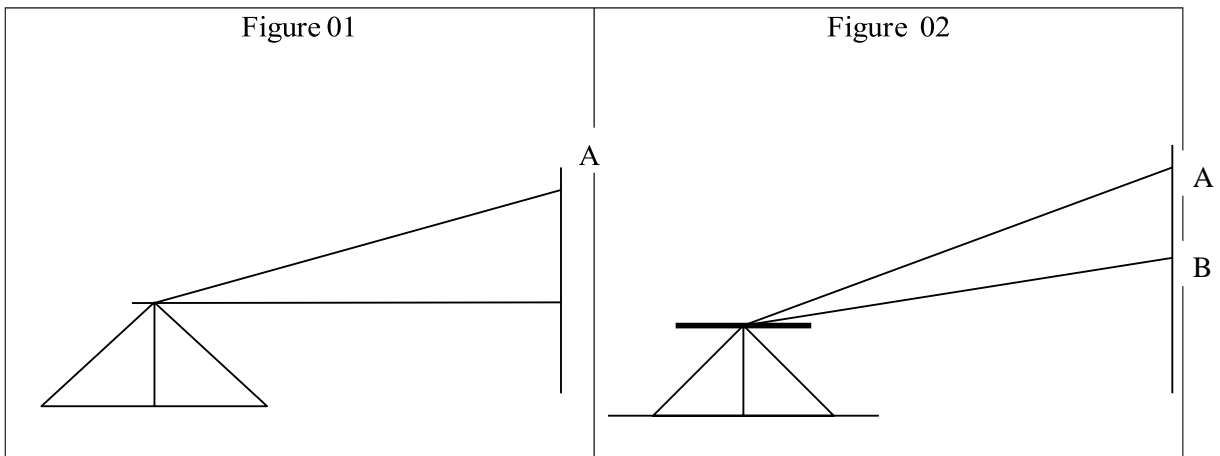
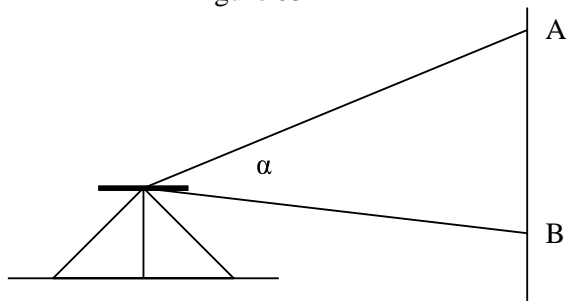

Figure 03



OBSERVATIONS

INSTRUMENT STATION	SIGHT TO	FACE LEFT						FACE RIGHT						AVERAGE VALUE
		'C' SCALE			'D' SCALE			'C' SCALE			'D' SCALE			
		Deg	Min	Sec	Deg	Min	Sec	Deg	Min	Sec	Deg	Min	Sec	

RESULT: The observed vertical angle = _____

*** **

**DETERMINING AN HEIGHT OF OBJECT BY MEASURING
VERTICAL ANGLE**

SURVEYING LAB

DATE:

OBJECTIVE: Determining a height of object by measuring vertical angle.

EQUIPMENTS :

1. Theodolite
2. Leveling Stop
3. Tape or Chain
4. Pegs
5. Plumb bob

SKETCH:

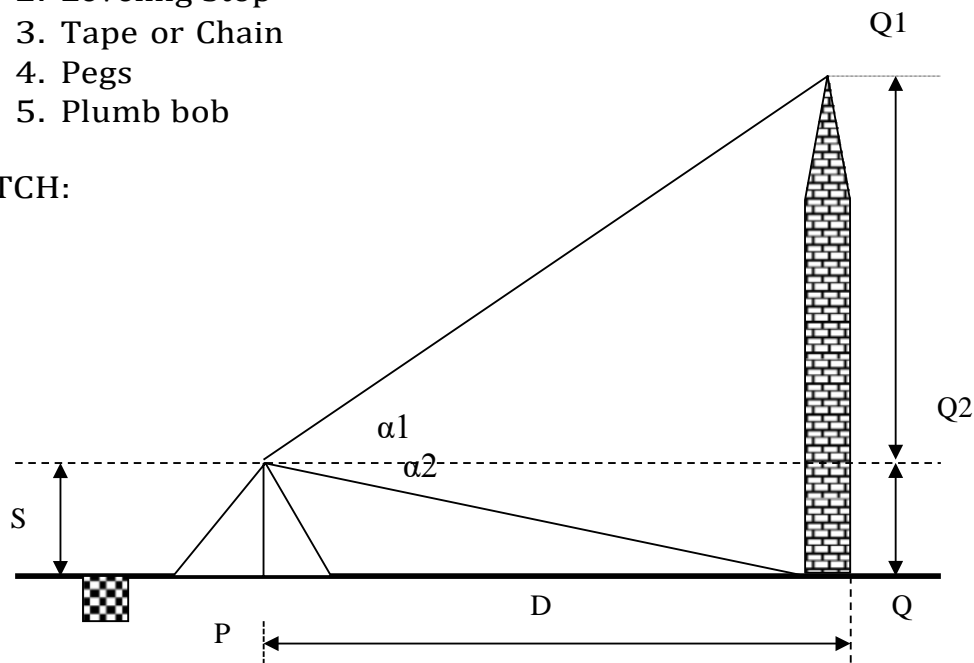

PROCEDURE:

1. Setup the instrument at station P.
2. Perform all temporary adjustments.
3. Bring the line of collimation horizontal
4. Enter the initial readings in the tabular form.
5. Swing the telescope and take staff reading over the given B.M.
6. Swing the telescope towards the object.
7. Release the vertical clamp screw, sight the top of the object Q1, and clamp the vertical clamp screw.
8. Read C and D verniers and enter the readings.
9. Release the vertical clamp screw, sight the bottom of the object Q, and clamp the screw.
10. Read vernier readings and enter in the tabular form.

11. Measure the Horizontal distance between the instrument station and the object.
12. The above procedure will be repeated with the face right observation.
13. The average of the two observations by transiting the telescope taken with different faces will be vertical angle.
14. Calculate the height of the top point Q_1 from horizontal line (h_1) and height of the bottom point Q_0 from horizontal line (h_2) by using formula $h = d \tan \alpha$

OBSERVATIONS

Average Vertical angle	“ Sec		
	‘ Min		
	.o Deg.		
Vertical Angle	“ Sec		
	‘ Min		
	.o Deg.		
FACE: RIGHT SWING: LEFT	Mean	“ Sec	
		‘ Min	
		.o Deg.	
	D	“ Sec	
		‘ Min	
	C	“ Sec	
		‘ Min	
		.o Deg.	
	Vertical angle	“ Sec	
		‘ Min	
		.o Deg.	
	FACE: LEFT SWING: RIGHT	Mean	“ Sec
‘ Min			
.o Deg.			
D		“ Sec	
		‘ Min	
C		“ Sec	
		‘ Min	
		.o Deg.	
Sighted to			
Instrumented to			

Formula:

$$h_1 = D \tan \alpha_1$$

$$h_2 = D \tan \alpha_2$$

$$.h = h_1 + h_2$$

TOPIC-6

PLOTTING

1. Conventional signs in surveying.
2. Plotting of land survey – Chain & Cross staff surveying
calculation of areas.
3. Plotting of chain triangulation of small areas around building.

Conventional signs in surveying

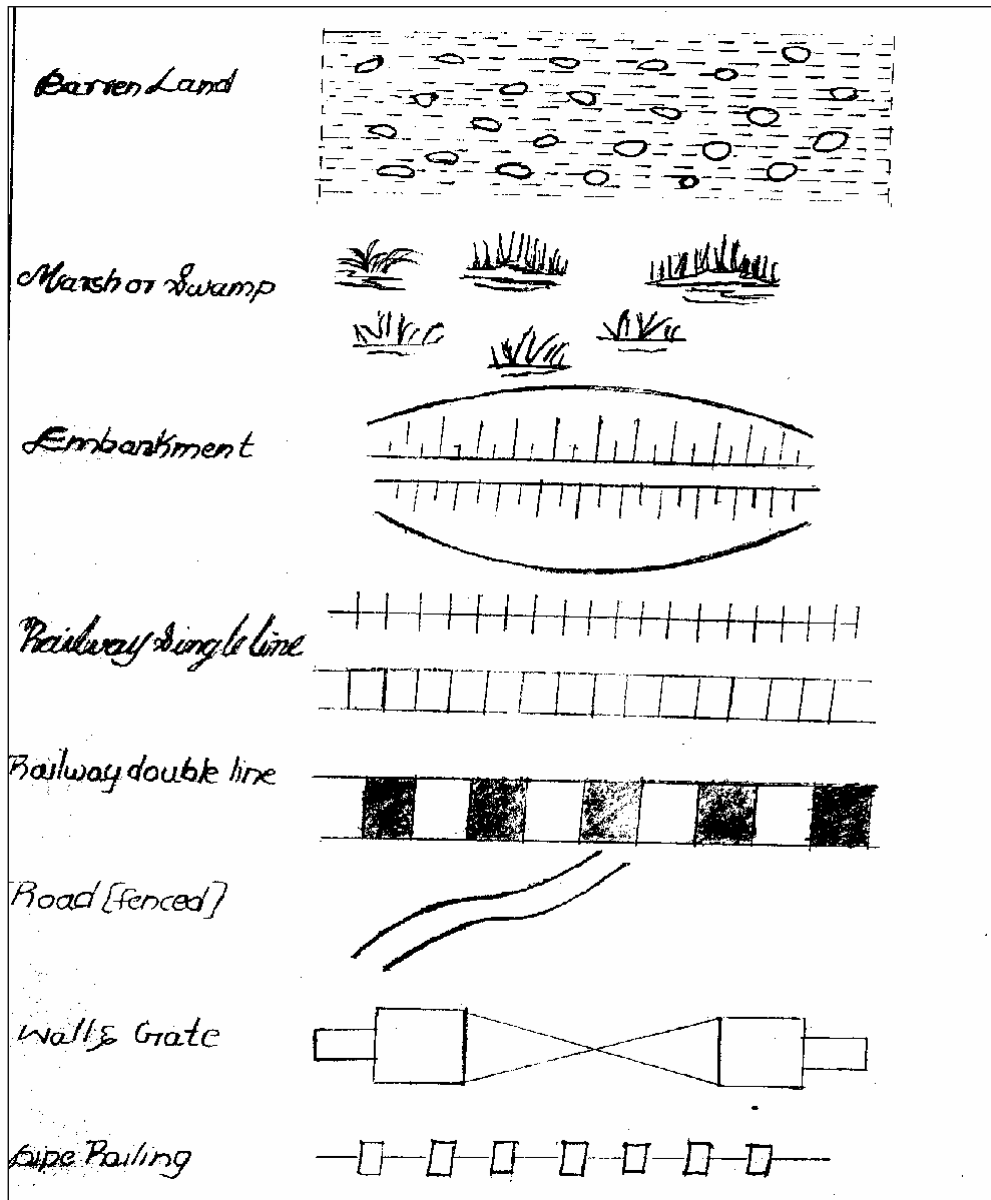

EXPERIMENT NO. 15

PLOTTING OF LAND SURVEY – CHAIN AND CROSS STAFF SURVEYING CALCULATION OF AREAS

OBJECTIVE: Plotting of land survey – chain and cross staff surveying – calculation of areas.

INSTRUMENTS:

1. Two Chains
2. Arrows
3. Ranging Rods
4. Cross staff
5. Plumb Bob

SKETCH:

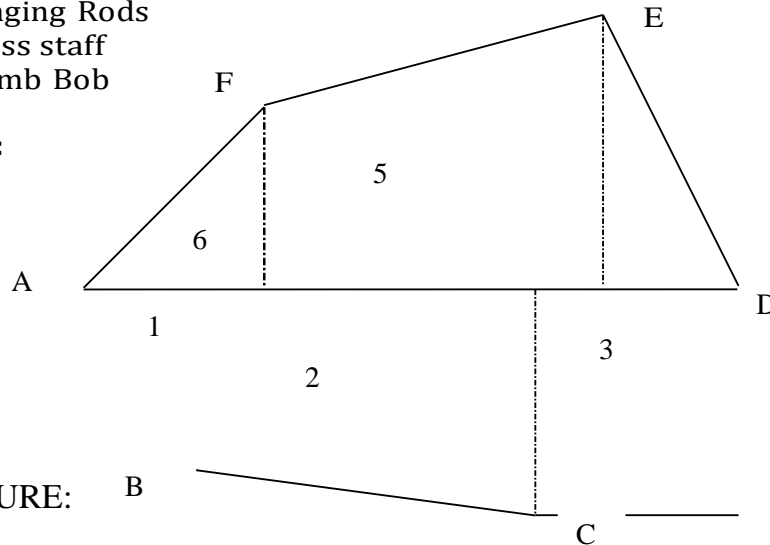

PROCEDURE:

1. Let A B C D E F be the given field whose area is to be measured.
2. Divide the area into right-angled triangles and Trapezoids and measure their bases and perpendiculars.
3. Two instruments are required
 - a. A cross staff to divide the area into triangles and trapezoids
 - b. A chain to measure lengths of base and perpendiculars.
4. Calculate the area of triangles and Trapezoids.
5. The sum of the areas of 1,2,3,4,5 and 6 gives the area of the given field.

FORMULA: Area of the right angled triangle = $\frac{1}{2}$ Base x Height

$$\text{Area of Trapezoid} = \frac{1}{2} (a + b) h$$

a, b are the parallel sides

h is the distance between the parallel sides.

**PLOTTING OF CHAIN TRIANGULATION OF SMALL AREAS
AROUND THE BUILDING**

SURVEYING LAB

DATE _____ :

OBJECTIVE: Plotting Of Chain Triangulation Of Small Areas Around The Building

INSTRUMENTS:

1. Chain 20m / 30 m - 1 No.
2. Ranging rods - 6 Nos.
3. Arrows - 10 Nos.
4. Pegs - 5 Nos.

PROCEDURE:

1. Prepare key plans for layout of plots.
2. Let A B C D E be the given field whose area is to be measured. Fix the pegs at A , B , C , D and E
3. Divide the given area into three triangles ADE, ABD and BDC by joining AD and BD.
4. Measure the lengths AB, CD, DE, EA and BD.
5. Calculate the area of the triangles.
6. The sum of the Three triangles is the area of the given field.

FORMULA:

$$\text{Area of the Triangle} = \sqrt{s(s-a)(s-b)(s-c)}$$

Where a, b, c are the sides of triangle

$$S = (a + b + c) / 2$$

SKETCH:

